

Enclosure series aluDISC-Ex

Type: AR 100 Ex-empty

Material-No.: 281.100.000

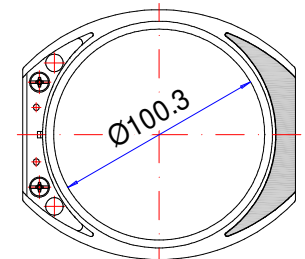
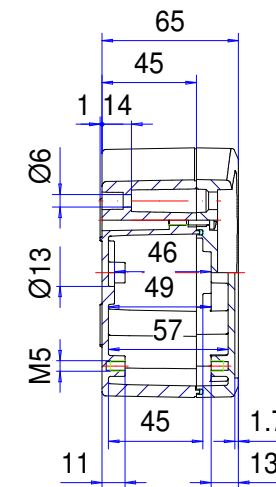
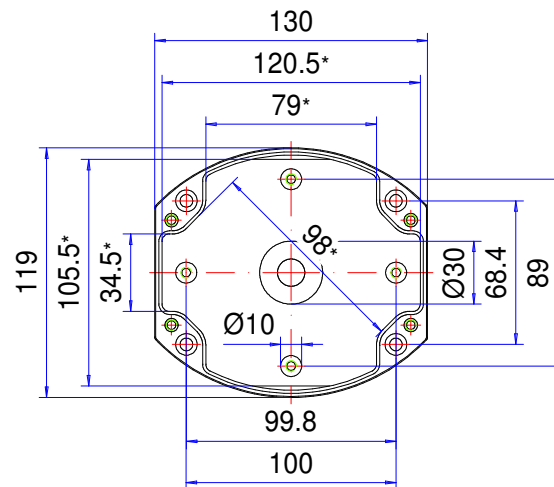
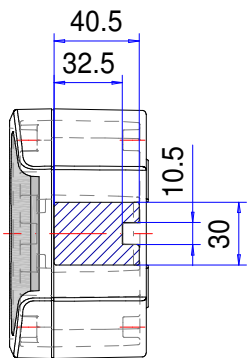
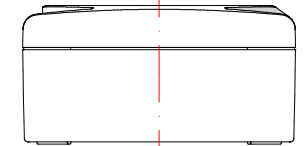
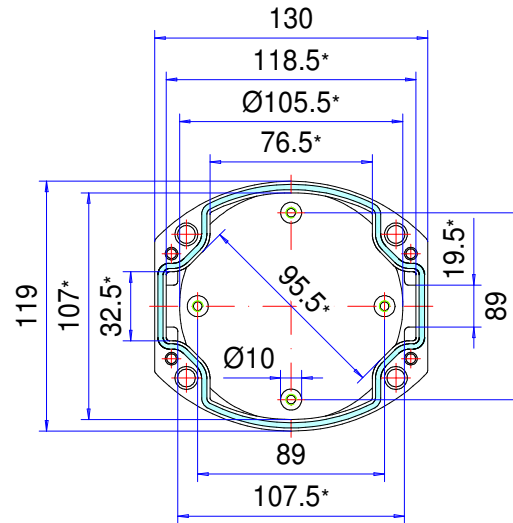

Folie/ Keypad
Ø99.7⁺⁰_{-0.2}

* Please note: Mould slope for casting ejection, dimensions in the amount of the bottom!

Enclosure material	GD-Al Si 12 (DIN 1725)		Ingress protection	IP66/67 EN 60529
Lid screws	4x stainless steel 1.4567 (V2A), captive		Weight	613 g
Assembly screws	5x M5x8, galvanized steel		Coating	Powder coating RAL 7035, light grey
Design covers	2x Polyoxymethylene (POM), RAL 7016, anthracite grey		Tolerance	GTA 13/5 DIN 1688-4 (outside dimensions ±0,5mm)
Gasket	1x moulded gasket, silicone, transparent		Grounding	Outside ground EN 60079-0