

Type: ADF 130

Material-No.: 133.130.000

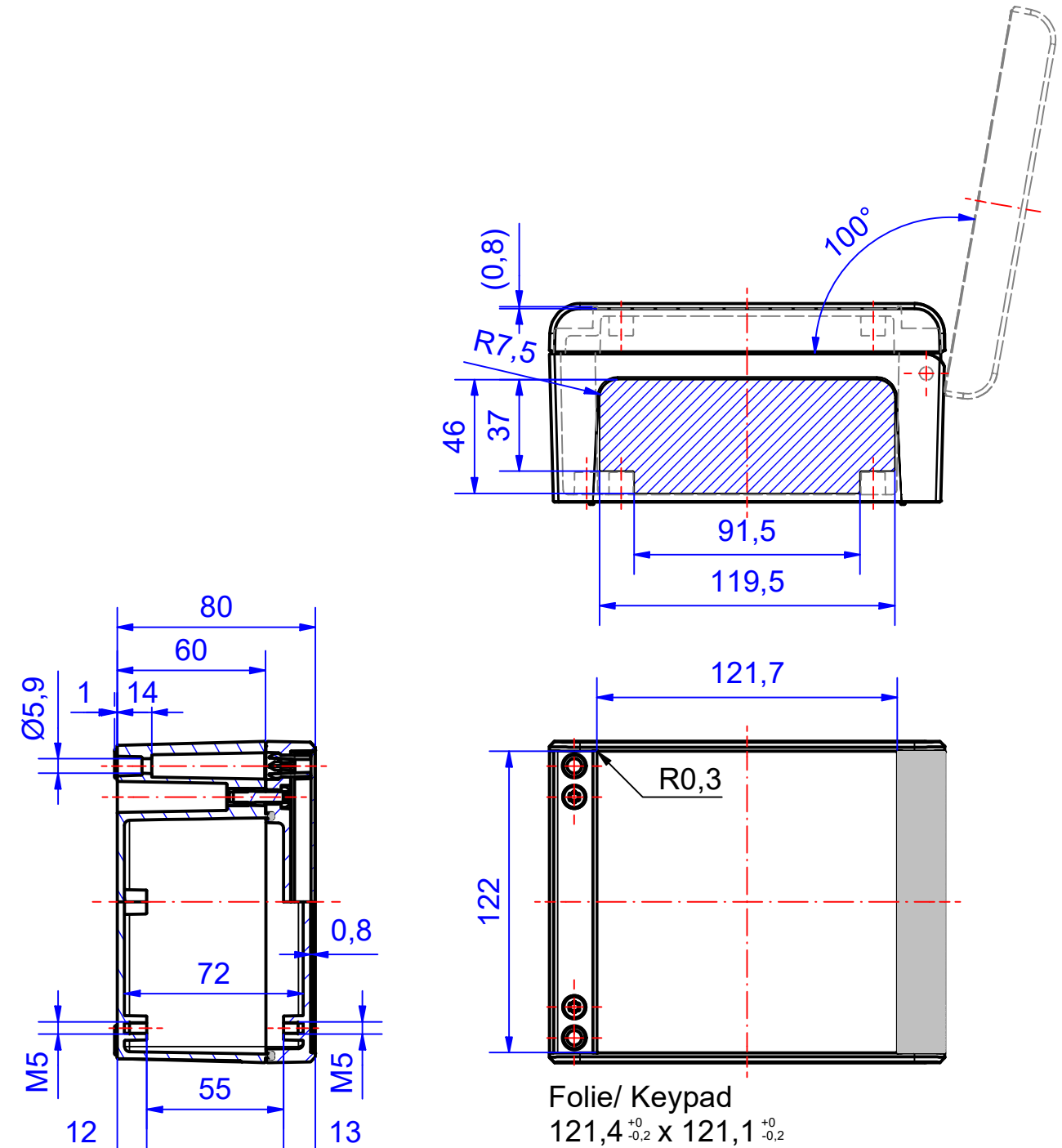
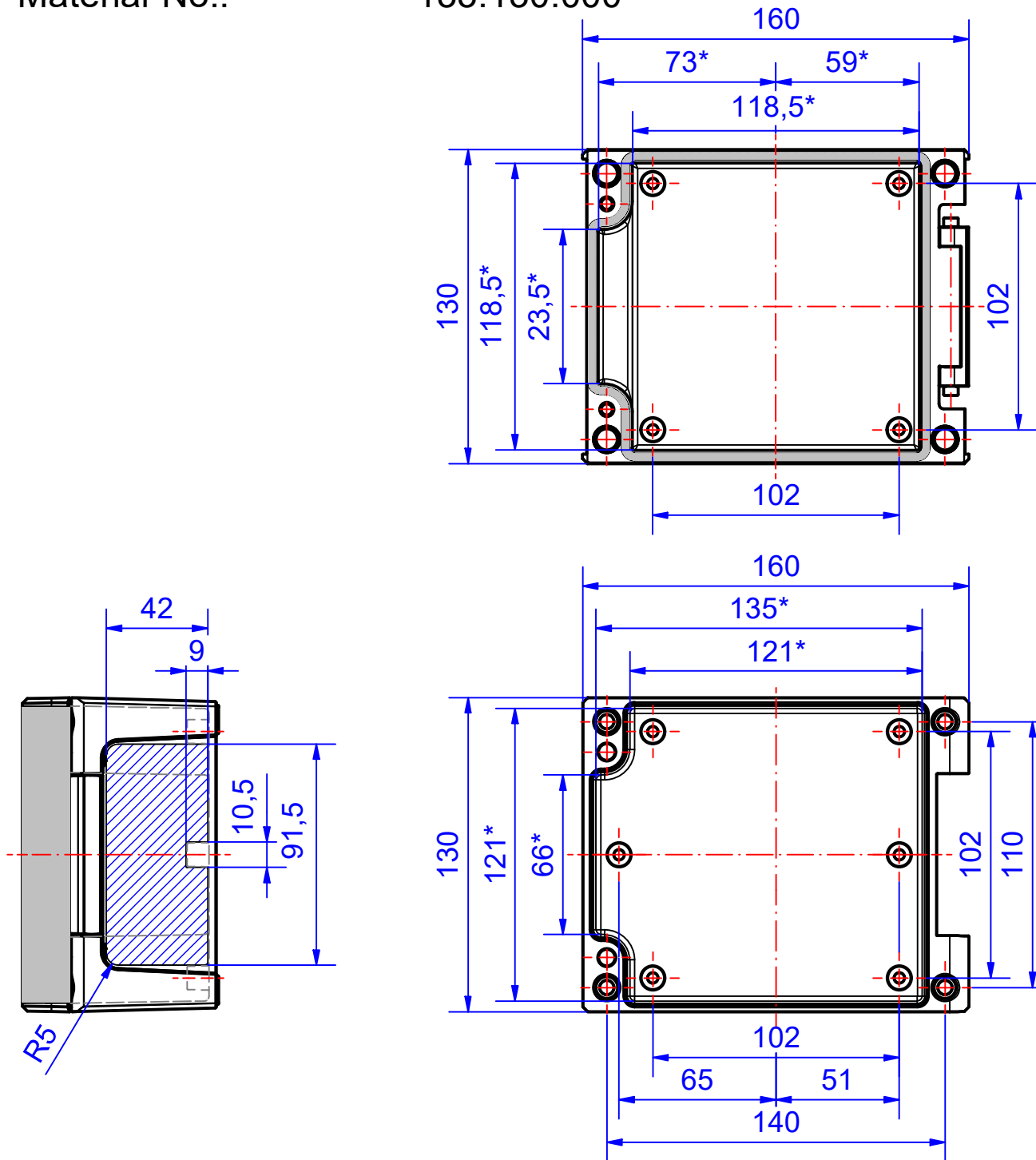

\* Please note: Enclosure with draft angles, dimensions in the amount of the bottom!

Enclosure material	EN-AC-AI Si 12 (DIN 1725)		Ingress protection	IP66/67 EN 60529, IP69K ISO 20653
Lid screws	1.4567, M5, Tx25,captive		Weight	945 g
Assembly screws	5x M5x8, Tx25, V2A		Coating	Powder coating RAL 7016, anthracite grey mat
Design covers	Powder coating, silver mat		Tolerance	DIN EN ISO 8062-3:2008-09 DCTG4 (outside dimensions ±0,5mm)
Gasket	Dosed, PUR			

**133.130.000**  
**aluDOOR ADF 130**

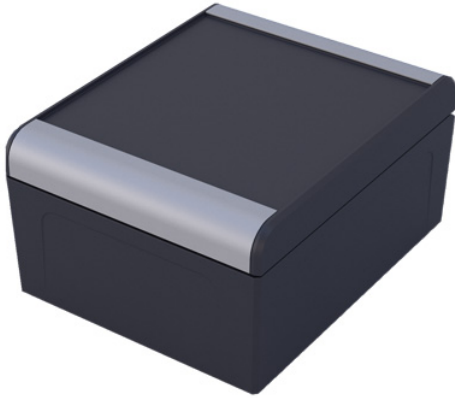

**Product overview**

Material	Aluminium
Protection Class	IP 66/EN 60529, IP 69K, IP 67/EN 60529, IP 68 (1,2m; 2h)
Color	RAL 7016
Length (L)	160 mm
Width (W)	130 mm
Height (H)	80 mm
Weight (g)	945 g

## aluDOOR

THE NEW, PREMIUM ENCLOSURE GENERATION, INCLUDING DOOR

**IP 66, IP 67, IP68 (1.2 m; 2 h), IP 69K**

### The key product features:

- Enclosure material: diecast aluminium
- Enclosure surface: powder coating, RAL 7016
- 100° opening angle
- Structurally integrated lid hinges
- Integrated recess in lid for membrane keypad or front plate
- Stainless steel lid screws and threaded inserts
- Enclosure lid without or with recess for fitting a membrane keypad or product label
- Clip-on design covers
- Enclosure seal: PUR
- Honoured with the German Innovation Award 2023

---

aluDOOR enclosures are a further development of the unique series aluCASE. This enclosure has an unmistakable progressive design. They are the modern, contemporary »packaging« for innovative industrial electronics.

The integration of true hinges without additional expenditure has been implemented successfully in the new series. After the »mounting« of the lid and the fixation with the securing screws, they turn into »compact cabinets« with stainless steel screws and stainless steel threaded bushings. Even under extreme operating conditions, this arrangement ensures an absolutely safe and permanent closure technology.

aluDOOR enclosures are available either with recesses in the lid for the installation of membrane keypads (ADF) or with a flat lid (ADO).

Finally, the installation level of the enclosures is covered by design covers made of aluminium (finished in matt silver), providing an unparalleled design. All enclosures have domes in bottom sections and lids for the secure fastening of installations.

### Enclosure sizes

10 - with 2 lid variants: ADF = Series with recess in the lid and ADO = Series with flat lid

### Further information

Integrated hinge function on side D with 2 securing screws (A2, self-forming)

Captive lid secured with two screws

Fastening with closed enclosure

Clip-on design covers, coated silver matt

Opening angle of the lid max. 100°

### Enclosure

Die cast aluminium alloy

EN AC-44300 DIN EN 1706

(GD Al Si 12/DIN 1725)

1° mould slope for casting ejection > Internal circumference dimensions decrease by 1° towards enclosure base

### **Fastening**

Separate screw channels

### **Internal mountings**

Fastening domes with M5 thread on the enclosure bottom and in the lid

### **Ingress protection**

IP 66, IP 67, IP 68 (1.2 m; 2 h) / EN 60529, IP 69K / ISO 20563

### **Gasket**

Foamed, polyurethane (PUR)

Optional: Silicone seal

Optional: EMC gasket

### **Surface**

Powder coating, RAL 7016

Design covers, silver matt powder coating

Optional: Special colours

Optional: Corrosion protection

### **Lid screws**

Stainless steel 1.4567, M5 with TX25, captive

### **Lid fastening thread**

Casting sleeves, stainless steel A2

### **Hinge**

Securing screws M5 self-forming for hinge attachment

### **ROLEC Service**

Utilise our [full service offer for installation-ready enclosures](#)

# Full-Service-Products

Customization according to your wishes.



Our passion is enclosures.



Expert advice

Everything begins with individual advice. We'll be pleased to support you with your project and find solutions for every requirement. Customer-specific solutions are our speciality.



Sample service

Test our products with your internal mounting. We'll be pleased to send you a sample enclosure for inspection with no strings attached.



Drilling

We'll manufacture every enclosure for you according to your exact specifications – whether they involve precise drilling or large tolerance.



Milling

Thanks to our modern CNC production, we can quickly and efficiently mill custom-fit cut-outs and contours to match your exact specifications.



Engraving

Our services also include engraving your logo and other elements, which we can of course perform in any colour you desire.



Lasering

We can process stainless steel enclosures and plates quickly and reliably according to your individual requirements thanks to our in-house lasering centre.



Powder coating

We can powder coat enclosures, command enclosures and suspension systems in any RAL colour you desire. Custom colours are of course also possible.



Painting

We can also paint all our enclosures in any RAL colour you desire. The application of primer and special colour structures are possible, as well.



Serigraphy

If desired, we can apply your logo and lettering or other markings using serigraph printing.



Digital printing

Digital printing is particularly worthwhile for low-volume orders and for realising complex patterns or images.



EMC enclosures

We offer our conFORM low-price standard EMC enclosure to protect your internal mounting against electromagnetic radiation. On request, we can also supply an EMC-compliant version of any other ROLEC enclosure.



Displays

We are able to offer the right made-to-measure display for all our enclosures – in varying sizes and degrees of robustness depending on the application.



Accessories

ROLEC's portfolio also includes matching front plates, mounting plate, supporting rails and terminal blocks as well as a range of cable glands, blanking plugs etc.



Assembly

Would you like to have all your components supplied already assembled? No problem. Our assembly team will be pleased to perform all assembly work on your behalf.



Our Service

If you have any requirements for services not listed here, please ask us. Customer-specific solutions are our speciality. We also are keen to take on unusual tasks.

We will help you with those challenges that many others would give up on.