

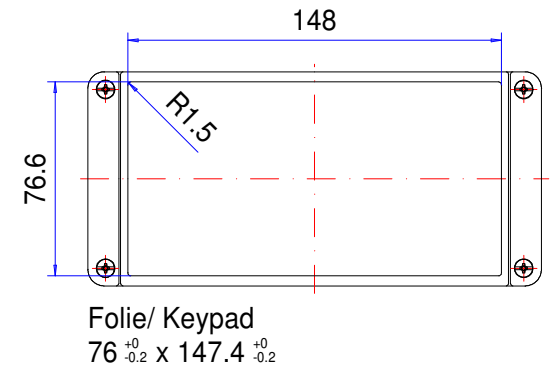

Enclosure series conTROL

Type: EKT 083

Material-No.: 310.083.000

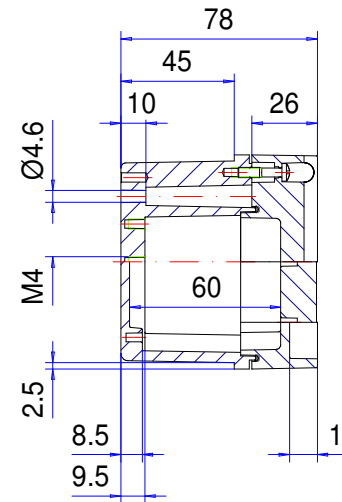
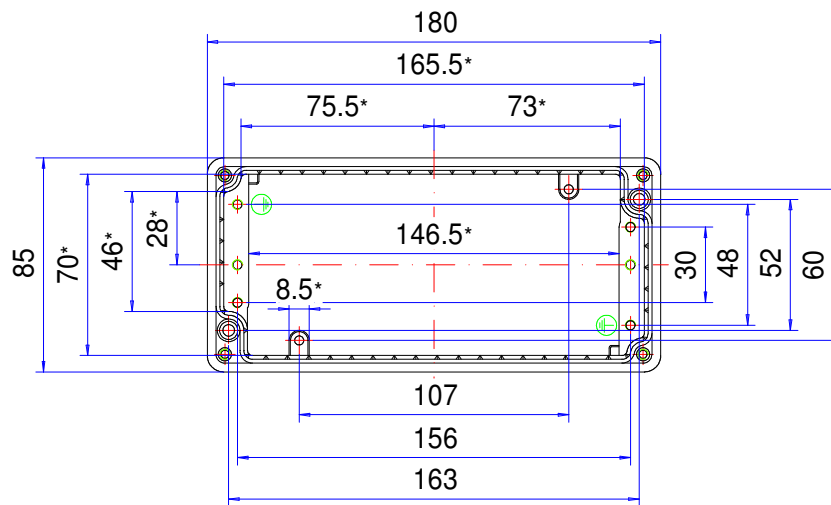
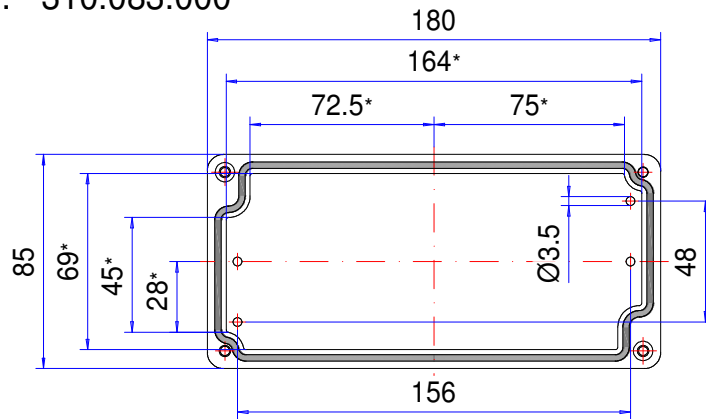

* Please note: Mould slope for casting ejection, dimensions in the amount of the bottom!

Enclosure material	GD-AI Si 12 (DIN 1725)		Weight	750 g
Lid screws	4x stainless steel 1.4567 (V2A), captive		Earthing screws	5x M4x6, galvanized steel
Gasket	1x TPE moulded gasket, siliconefree, black		Coating	Powder coating RAL 7032, pebble grey
Ingress protection	IP66 EN 60529		Tolerance	GTA 13/5 DIN 1688-4 (outside dimensions ±0,5mm)

310.083.000
control EKT 083



Product overview

Material	Aluminium
Protection Class	IP 66/EN 60529, IP 67/EN 60529
Color	RAL 7032
Length (L)	180 mm
Width (W)	85 mm
Height (H)	78 mm
Weight (g)	750 g

conTROL

THE EMC OPERATING ENCLOSURE

IP 66, Optional: IP 67

The key product features:

- Enclosure material: diecast aluminium
- Enclosure surface: powder coating, RAL 7032
- High inner collar
- Tooth system in the bottom section for continuous contact
- Cover with high protective collar
- Sizes compatible with standard enclosures available on the market, therefore easy to exchange
- Lid screws in stainless steel 1.4567
- Enclosure seal: TPE moulded gasket

conTROL is a robust and versatile range of EMC shielded aluminium enclosures which is ideal for machine control equipment. The enclosures feature in-built shielding that does not require expensive and delicate conductive gaskets. Continuous contact is created by means of a patented tooth system pre-cast into the lid and base.

Standard features include a deep recessed lid which is designed to protect buttons and control switches. The enclosures are water-tight and weather resistant to IP 66. Threaded screw bosses are provided inside for fitting circuit boards, mounting plates, terminal rails etc. Accessories such as mounting plates and cable glands are also available.

We can supply conTROL enclosures fully customised to your requirements.

Enclosure sizes

4

Additional info

High shielding from radiation interference (EMC tested by the University of Hanover)

Collar protects command and information buttons

Inexpensive, as there is no need for expensive conductive gaskets

Large range of accessories

Enclosure

Diecast aluminium alloy

EN AN-44300 DIN EN 1706

(GD Al Si 12/DIN 1725)

1° mould slope for casting ejection > internal circumference dimensions decrease by 1° towards enclosure bottom.

Fastening

Separate screw channels outside of the enclosure interior

Console panel integration with installation kit

Internal mounting

M4 fastening thread in lateral bars on the enclosure base and optional fastening on the lid

Ingress protection

IP 66 / EN 60529

Optional: IP 67 / NEMA 4

Gasket

TPE moulded gasket, silicone-free

Optional: Silicone gasket

Lid screws

Stainless steel 1.4567, captive

Surface

Powder coating RAL 7032, silky grey

Optional: Special colours

Optional: Corrosion protection

Customising

Learn more about our [full customising service for installation-ready enclosures](#)

Full-Service-Products

Customization according to your wishes.



Our passion is enclosures.



Expert advice

Everything begins with individual advice. We'll be pleased to support you with your project and find solutions for every requirement. Customer-specific solutions are our speciality.



Sample service

Test our products with your internal mounting. We'll be pleased to send you a sample enclosure for inspection with no strings attached.



Drilling

We'll manufacture every enclosure for you according to your exact specifications – whether they involve precise drilling or large tolerance.



Milling

Thanks to our modern CNC production, we can quickly and efficiently mill custom-fit cut-outs and contours to match your exact specifications.



Engraving

Our services also include engraving your logo and other elements, which we can of course perform in any colour you desire.



Lasering

We can process stainless steel enclosures and plates quickly and reliably according to your individual requirements thanks to our in-house lasering centre.



Powder coating

We can powder coat enclosures, command enclosures and suspension systems in any RAL colour you desire. Custom colours are of course also possible.



Painting

We can also paint all our enclosures in any RAL colour you desire. The application of primer and special colour structures are possible, as well.



Serigraphy

If desired, we can apply your logo and lettering or other markings using serigraph printing.



Digital printing

Digital printing is particularly worthwhile for low-volume orders and for realising complex patterns or images.



EMC enclosures

We offer our conFORM low-price standard EMC enclosure to protect your internal mounting against electromagnetic radiation. On request, we can also supply an EMC-compliant version of any other ROLEC enclosure.



Displays

We are able to offer the right made-to-measure display for all our enclosures – in varying sizes and degrees of robustness depending on the application.



Accessories

ROLEC's portfolio also includes matching front plates, mounting plate, supporting rails and terminal blocks as well as a range of cable glands, blanking plugs etc.



Assembly

Would you like to have all your components supplied already assembled? No problem. Our assembly team will be pleased to perform all assembly work on your behalf.



Our Service

If you have any requirements for services not listed here, please ask us. Customer-specific solutions are our speciality. We also are keen to take on unusual tasks.

We will help you with those challenges that many others would give up on.