

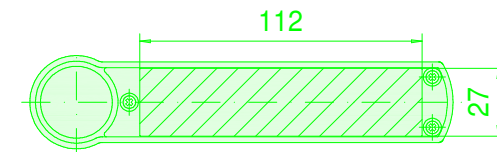

Enclosure series mobilCASE

Type: P 130-2

Material-No.: 251.130.240, Length (L) of profile variable

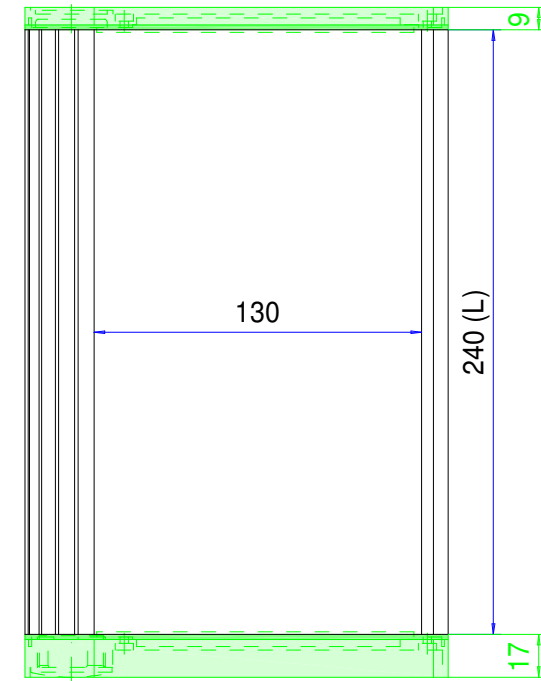
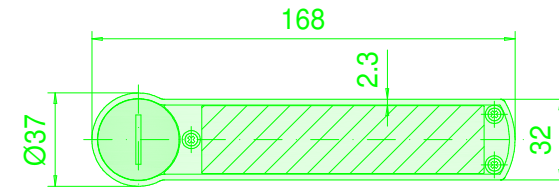
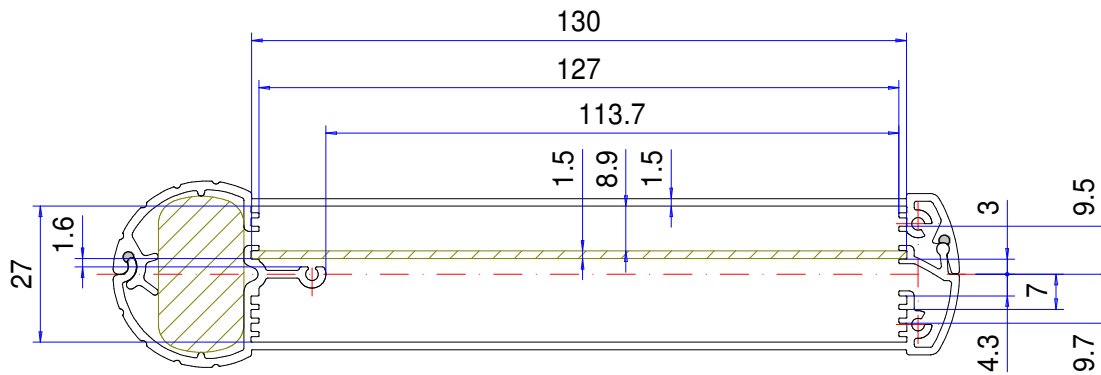

Enclosure material	Al Mg Si 0.5 (DIN 17615)		Ingress protection	IP54 EN 60529
Lid material	GD-Zn Al 4 Cu 1 (DIN EN 12844)		Weight	Profile 2,202 kg/m
Lid screws	6x stainless steel 1.4567 (V2A), captive		Coating profile	Powder coating silver metallic
Gasket profile	2x Chloroprene (CR), light grey		Coating lid	Powder coating RAL 9005, black
Gasket lid	2x TPE moulded gasket, siliconefree, black		Tolerance	GTA 13/5 DIN 1688-4 (outside dimensions ±0,5mm)