

132.104.000
polyTOP PT 104



technical data

Material	Polyester
Protection class	IP 66/EN 60529, IP 67/EN 60529
Colour	Pebble grey RAL 7032
Certifications	CSA (optional), GOST, Germanischer Lloyd (optional), UL (optional)
Length	202 mm
Width	102 mm
Height	81 mm
Weight (g)	770 g
Country of manufacture	Germany
Customs tariff number	39269097

polyTOP

MODERN HIGHLY RESISTANT ENCLOSURES IN GLASS-FIBRE REINFORCED POLYESTER

IP 66 - Optional: IP 67

polyTOP is a range of IP 66 enclosures made of highly resistant glass-fibre reinforced polyester. The enclosures are ideal for industrial electronics and control equipment used in harsh indoor and outdoor applications.

Special features include corrosion-resistant polyamide lid fixings in four different designs: slotted (standard), triangular or square head for tamper protection, and hand screws for fast access. Threaded M6 fixing pillars are provided inside for mounting terminal rails, circuit boards, mounting plates etc. polyTOP is available in a wide range of standard sizes. Supporting rails, terminals, cable glands and other accessories are also available.

We can supply polyTOP enclosures fully customised to your requirements.

Enclosure sizes
13 sizes

Dimensions L x W x H

82 x 82 x 60mm to 404 x 404 x 160mm

Further information

Improved technology thanks to the single-channel lid and assembly fastening

Compatible assembly dimensions with the aluNORM range

Full protective insulation in accordance with VDE 0100

Enclosure

Polyester glass fibre reinforced, halogen-free

similar to RAL 7032, pebble grey, surface resistance < 10⁹ Ohm

Optional: similar to RAL 9005, deep black, surface resistance < 10⁹ Ohm

1° mould slope for casting ejection > internal circumference dimensions decrease by 1° towards enclosure bottom.

Flammability

UL 94 V-0

Fastening

Single-channel lid and assembly fastening outside of the enclosure interior, stainless steel external mounting brackets

Internal mounting
M4/M6 threaded bushing on the enclosure base

Ingress protection
IP 66 / EN 60529

Optional: IP 67 / EN 60529

Gasket
EPDM O-ring gasket, temperature resistance: -40°C to +110°C

Optional: Silicone gasket, temperature resistance: -50°C to +140°C

Lid screws
Polyamide, corrosion-resistant and captive, slotted design
Optional: Various locking screws available

Customising
Learn more about our full customising service for installation-ready enclosures

Enclosure series polyTOP

Type: PT 104

Material-No.: 132.104.000

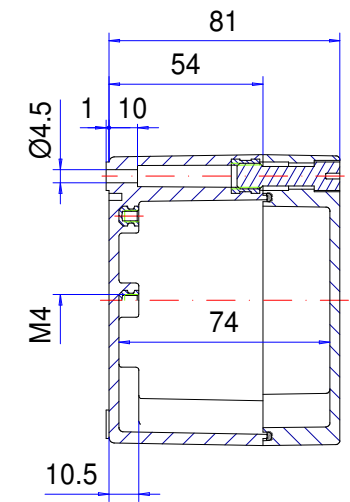
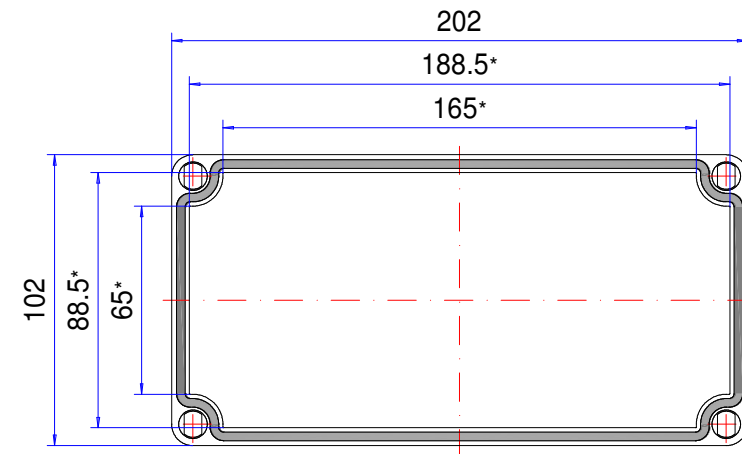
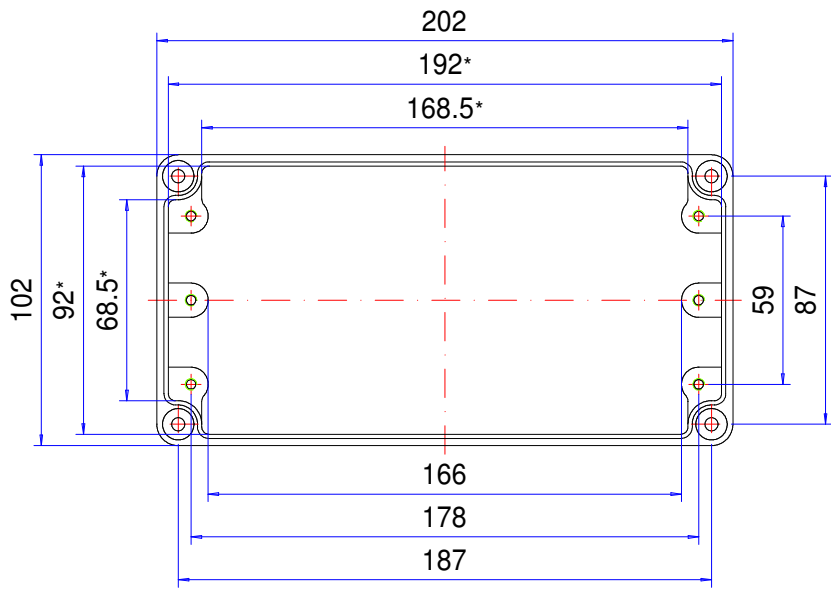

* Please note: Mould slope for casting ejection, dimensions in the amount of the bottom!

Enclosure material	Polyester GrP, UL 94 V-0, RAL 7032, pebble grey		Ingress protection	IP66 EN 60529
Lid screws	4x Polyamide (PA), captive		Weight	770 g
Gasket	1x Chloroprene (CR), light grey		Tolerance	DIN ISO 16901 T-130 (outside dimensions ±0,5mm)