

130.162.000
polyDOOR PD 162



technical data

Material	Polyester
Protection class	IP 66/EN 60529
Colour	Pebble grey RAL 7032
Certifications	CSA (optional), GOST, UL (optional)
Length	260 mm
Width	160 mm
Height	100 mm
Weight (g)	1500 g
Country of manufacture	Germany
Customs tariff number	39269097

polyDOOR

HIGHLY RESISTANT GRP POLYESTER ENCLOSURES WITH HINGED FRONT LIDS

IP 66

polyDOOR is a range of weather-resistant IP 66 enclosures in glass-fibre reinforced polyester that features a hinged front lid for easy access. The enclosures are ideal for industrial electronics and control equipment used in harsh indoor and outdoor applications.

Special features include integrated hinges for opening the lid, transparent front windows and optional lid fixings: slotted (standard), triangular or square head for tamper protection, and hand screws for fast access. Threaded fixing pillars are provided inside for mounting the components. polyDOOR is available in a wide range of standard sizes. Cable glands and other accessories such as terminal rails and mounting plates are also available.

We can supply polyDOOR enclosures fully customised to your requirements.

Enclosure sizes

8 sizes with closed lid or with a viewing panel in the lid

Dimensions L x W x H

140 x 120 x 100mm to 320 x 200 x 120mm

Further information

Corrosion-resistant lid fastening thread made from stainless steel

Various locking screws available

Application-specific accessories available

Full protective insulation in accordance with VDE 0100

Enclosure

Polyester glass fibre reinforced, halogen-free

similar to RAL 7032, pebble grey, surface resistance < 10⁹ Ohm

Optional: similar to RAL 9005, deep black, surface resistance < 10⁹ Ohm

1° mould slope for casting ejection > internal circumference dimensions decrease by 1° towards enclosure bottom.

Flammability

UL 94 V-0, self-extinguishing

Fastening

Single-channel lid and assembly fastening outside of the enclosure interior

Optional: External mounting brackets made from stainless steel

Internal mounting

M6 fastening thread on the enclosure floor

Ingress protection
IP 66 / EN 60529

Gasket
EPDM O-ring gasket, temperature resistance: -40°C to +110°C

Optional: Silicone gasket, temperature resistance: -50°C to +140°C

Lid screws
Polyamide, corrosion-resistant and captive, slotted design
Optional lid screws: triangular, square and hand screw

Customising
Learn more about our full customising service for installation-ready enclosures

Enclosure series polyDOOR

Type: PD 162

Material-No.: 130.162.000

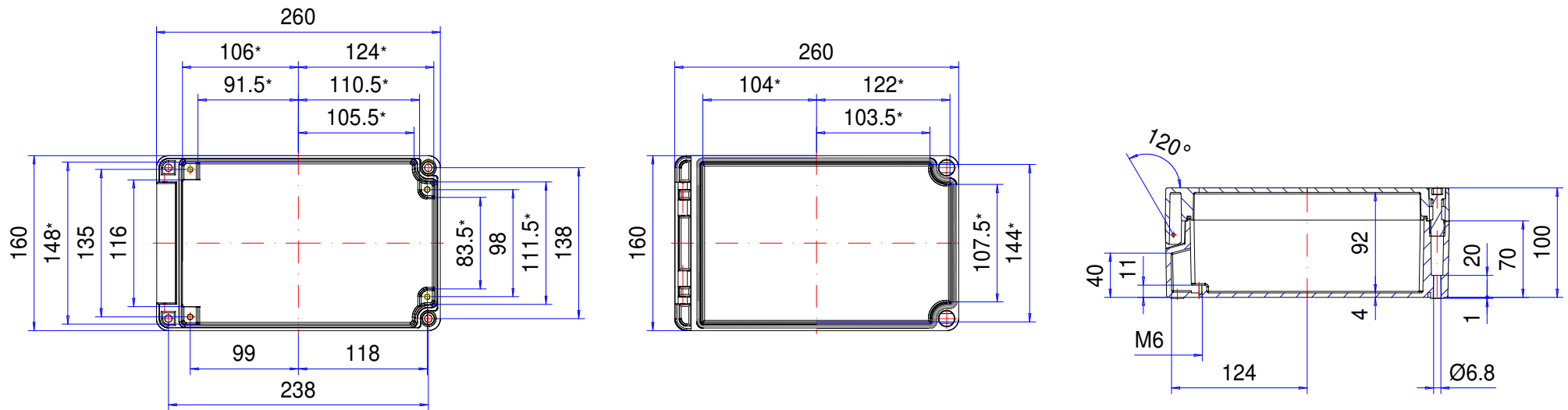

* Please note: Mould slope for casting ejection, dimensions in the amount of the bottom!

Enclosure material	Polyester GrP, UL 94 V-0, RAL 7032, pebble grey		Ingress protection	IP66 EN 60529
Lid screws	2x Polyamide (PA), captive		Weight	1.500 g
Gasket	1x Chloroprene (CR), light grey		Tolerance	DIN ISO 16901 T-130 (outside dimensions ±0,5mm)