

194.202.000
commandCASE CCS 202



technical data

Material	Aluminium
Protection class	IP 66/EN 60529
Colour	Light grey RAL 7035
Certifications	GOST, UL (optional)
Length	330 mm
Width	200 mm
Height	120 mm
Weight (g)	3038 g
Country of manufacture	Germany
Customs tariff number	76169910

commandCASE

MODERN COST-EFFECTIVE COMMAND ENCLOSURES THAT INSPIRE DIFFERENT THINKING

IP 66

commandCASE is an elegant and economic range of diecast command and control enclosures. The highly attractive design perfectly matches our profiPLUS suspension arm system, or other modern arms systems. All models feature ergonomic handles on the front for easy positioning when suspended.

The range is available in three versions: with hinges and quick-action closure (also lockable), with hinges and screw fixing or as a fully screw fixed version. Lid supports provide strain-relief. The front is recessed to accommodate a membrane keypad, front plate or display panel. At the rear the screw channels are fitted with cover caps which also serve as edge protection. Threaded screw bosses are provided inside for mounting assemblies and components. Mounting plates, matching cable glands and other accessories are also available.

We can supply commandCASE enclosures fully customised to your requirements.

Enclosure sizes
6 sizes in 3 variants

Dimensions of L x W x H

230 x 200 x 120mm to 430 x 300 x 120mm

Additional info
Designer handles

Integrated recess in the lid for membrane keypad or front plates

End caps made from polyoxymethylene (POM), RAL 7016 anthracite grey

Integrated lid support, PP (polypropylene), RAL 7040 window grey

Optional: Quick-acting closure and hinge, narrow side (side W)

Enclosure
Die-cast aluminium alloy

EN AN-44300 DIN EN 1706

(GD Al Si 12/DIN 1725)

1° mould slope for casting ejection > internal circumference dimensions decrease by 1° towards enclosure bottom.

Fastening

On a ROLEC suspension arm system or directly attached to the wall in the version with lock and hinge - with or without designer handles

Internal mounting

M5 fastening thread on the enclosure base and in the lid

Ingress protection

IP 66 / EN 60529

Gasket

Chloroprene O-ring gasket (CR), temperature resistance: -30°C to +90°C

Optional: Silicone O-ring gasket, temperature resistance: -50°C to +140°C

Surface

Powder coating RAL 7035, light grey

Optional: Special colours

Optional: Corrosion protection

Customising

Learn more about our full customising service for installation-ready enclosures

Enclosure series commandCASE

Type: CCS 202

Material-No.: 194.202.000

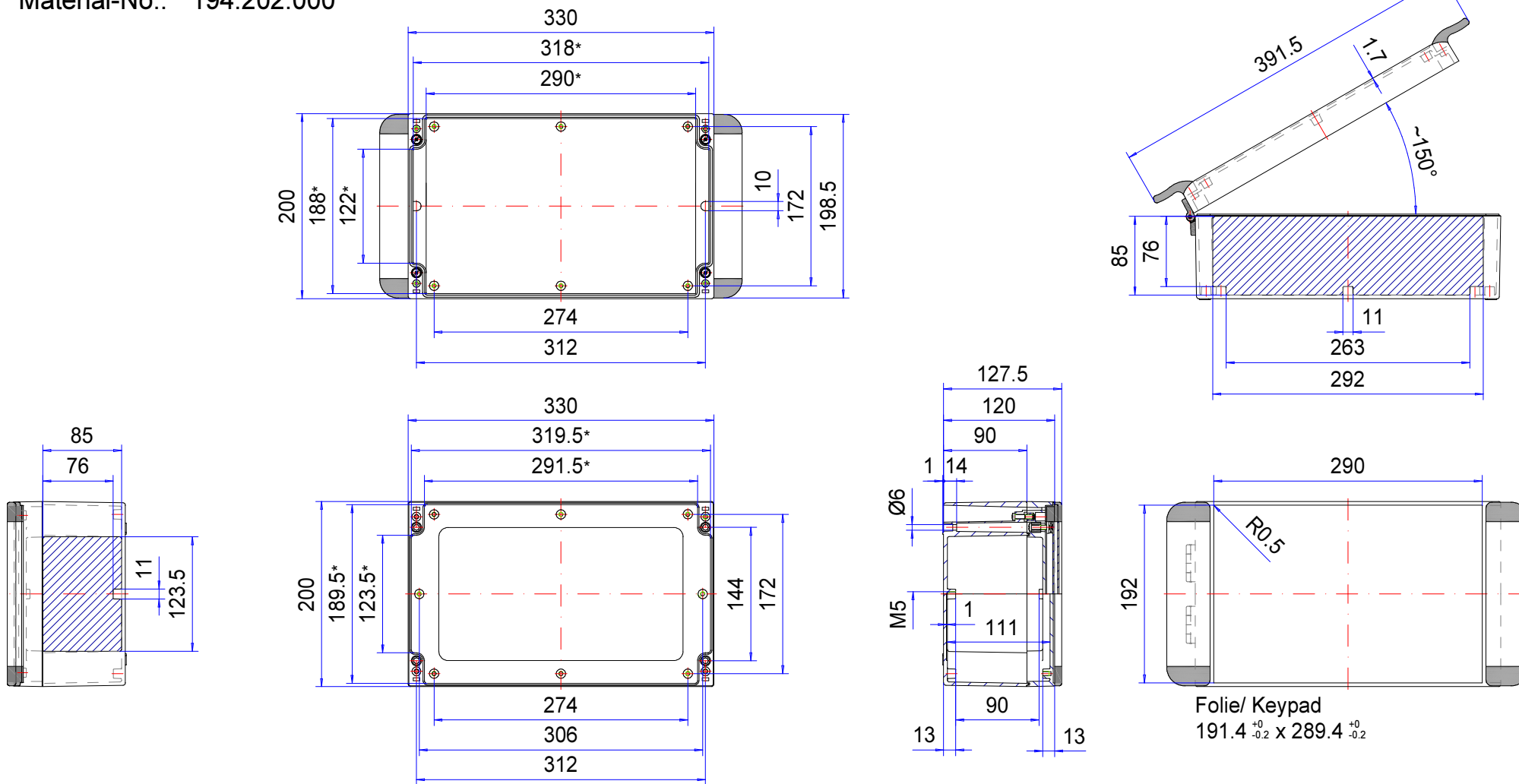

* Please note: Mould slope for casting ejection, dimensions in the amount of the bottom!

Enclosure material	GD-Al Si 12 (DIN 1725)		Ingress protection	IP66 EN 60529
Closure	2x hinge + 2x screw stainless steel 1.4567 (V2A), captive		Weight	3.095 g
Design grip "wings"	2x Aluminium anodized, 4x edge (POM), anthrazite grey		Coating	Powder coating RAL 7035, light grey
Assembly screws	5x M5x8, galvanized steel		Tolerance	GTA 13/5 DIN 1688-4 (outside dimensions ±0,5mm)
Gasket	1x Chloroprene (CR), light grey			