

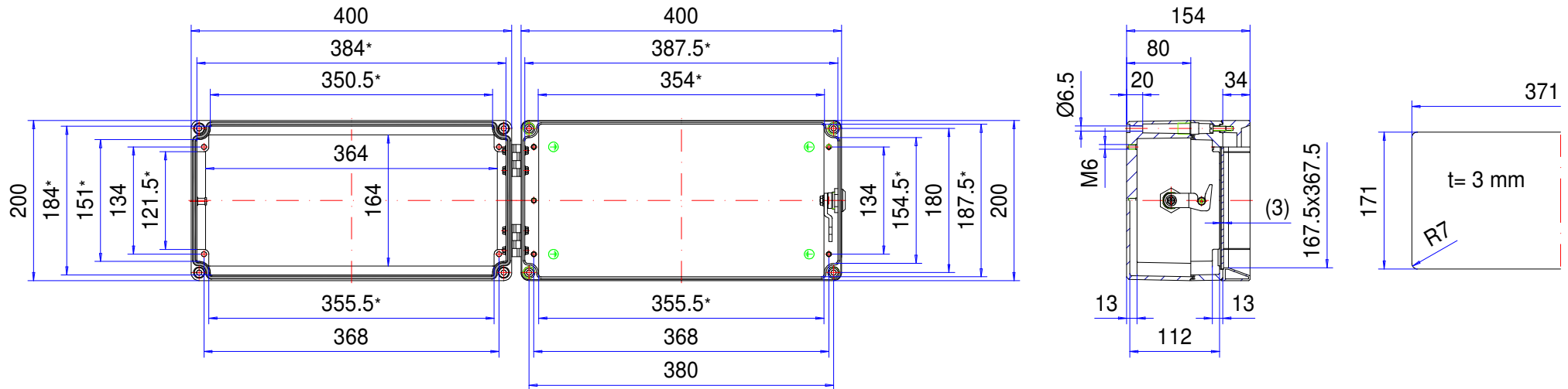

Enclosure series aluFACE

Type: KSE 204

Material-No.: 115.204.000



* Please note: Mould slope for casting ejection, dimensions in the amount of the bottom!

Enclosure material	GD-Al Si 12 (DIN 1725)		Weight	5.860 g
Closure	1x lock and 2x hinge		Earthing screws	4x M6x9, copper-plated
Gasket	1x TPE moulded gasket, siliconefree, black		Coating	Powder coating RAL 7040, window grey + RAL 7035, light grey
Ingress protection	IP66 EN 60529		Tolerance	GTA 13/5 DIN 1688-4 (outside dimensions ±0,5mm)

115.204.000
aluFACE KSE 204



Product overview

Material	Aluminium
Protection Class	IP 65/66 EN 60529
Color	RAL 7040, RAL 7035
Length (L)	400 mm
Width (W)	200 mm
Height (H)	153 mm
Weight (g)	5860 g

aluFACE

THE ECONOMICAL OPERATING AND CONTROL ENCLOSURE

IP 65, IP 66

The most important product features:

- Enclosure material: diecast aluminium. Framework: corner pieces from diecast zinc and aluminium profiles
- Front plate: 3 mm aluminium, anodised silver
- Enclosure surface: powder coating, RAL 7040/7035
- KE: 1-piece framework
- KCE/KSE: 2-piece lid with flat or high framework, integrated lock and hinges
- KVE/KVF: 2-piece lid with flat framework and bottom
- Single-channel mounting for greater installation volume
- Ideal connection to the suspension systems taraPLUS, profiPLUS and taraSMART
- Lid screws stainless steel 1.4567
- Enclosure seal: TPE moulded gasket, silicone-free, O-ring gasket (CR), Profile seal (CR)

aluFACE is a robust and highly versatile range of command and control enclosures which feature fixed or hinged front sections. The enclosures are ideal all types of industrial controls and display technology.

The aluFACE range is available in six different versions with diecast aluminium base sections and diecast or extruded frame lids. The enclosures are supplied with an anodised aluminium front panel which is recessed to protect controls and keypads. Internal threaded screw bosses are provided for fixing PCBs, support rails, mounting plates etc. The larger enclosures in the range can be mounted to our [suspension arm systems](#).

We can supply aluFACE enclosures fully customised to your requirements.

Enclosure sizes

6 variants - 66 dimensions

KTE range: Secure connection technology in connection space (opened independently), both chambers can be separated, various lid variants, ingress protection IP 66

KE range: Flat framework, single-piece aluminium frame, front plate without visible screws, aluminium front plate, easy to assembly, ingress protection IP 66

KSE range: High framework, two-piece lid, with lock and hinges, ingress protection IP 65

KCE range: High framework, two-piece lid, with lock and hinges, ingress protection IP 65

KVE range: Flat framework, two-piece lid, inexpensive screwed version, ingress protection IP 65

KVF range: Flat framework, flat bottom, two-piece lid, inexpensive screwed version, ingress protection IP 65

Additional info

Enclosure

Diecast aluminium

EN AC 44300/EN AC-44200 (DIN EN 1706)

1° mould slope for casting ejection > internal circumference dimensions decrease by 1° towards enclosure bottom.

Front door (KSE/KCE range): Extruded aluminium profiles

Diecast zinc corner pieces with standard front plate: Aluminium 3 mm, Al Mg 1, silver anodised

Optional: Finished front plates, bored, stamped, engraved or printed

Optional: Steel pipe handle frame, powder coated, RAL 3020, traffic red or RAL 9005 black



Closure (KSE/KCE range): Hinges and locks on the narrow sides (side W), optionally also on the long sides (side L)

Fastening

With ROLEC suspension arm system [taraPLUS](#) and [profiPLUS](#) or attached to wall

Internal mounting

Fastening thread M6 on the enclosure floor

Ingress protection

IP 65, IP 66 / EN 60529

Gasket

Depends on variant and size:

Chloroprene O-ring gasket (CR)

or TPE moulded gasket, silicone-free

Surface

Powder coating

Enclosure: RAL 7035, light grey

Front frame: RAL 7040, window grey

Optional: Special colours

Customising

Learn more about our [full customising service for installation-ready enclosures](#)

Full-Service-Products

Customization according to your wishes.



Our passion is enclosures.



Expert advice

Everything begins with individual advice. We'll be pleased to support you with your project and find solutions for every requirement. Customer-specific solutions are our speciality.



Sample service

Test our products with your internal mounting. We'll be pleased to send you a sample enclosure for inspection with no strings attached.



Drilling

We'll manufacture every enclosure for you according to your exact specifications – whether they involve precise drilling or large tolerance.



Milling

Thanks to our modern CNC production, we can quickly and efficiently mill custom-fit cut-outs and contours to match your exact specifications.



Engraving

Our services also include engraving your logo and other elements, which we can of course perform in any colour you desire.



Lasering

We can process stainless steel enclosures and plates quickly and reliably according to your individual requirements thanks to our in-house lasering centre.



Powder coating

We can powder coat enclosures, command enclosures and suspension systems in any RAL colour you desire. Custom colours are of course also possible.



Painting

We can also paint all our enclosures in any RAL colour you desire. The application of primer and special colour structures are possible, as well.



Serigraphy

If desired, we can apply your logo and lettering or other markings using serigraph printing.



Digital printing

Digital printing is particularly worthwhile for low-volume orders and for realising complex patterns or images.



EMC enclosures

We offer our conFORM low-price standard EMC enclosure to protect your internal mounting against electromagnetic radiation. On request, we can also supply an EMC-compliant version of any other ROLEC enclosure.



Displays

We are able to offer the right made-to-measure display for all our enclosures – in varying sizes and degrees of robustness depending on the application.



Accessories

ROLEC's portfolio also includes matching front plates, mounting plate, supporting rails and terminal blocks as well as a range of cable glands, blanking plugs etc.



Assembly

Would you like to have all your components supplied already assembled? No problem. Our assembly team will be pleased to perform all assembly work on your behalf.



Our Service

If you have any requirements for services not listed here, please ask us. Customer-specific solutions are our speciality. We also are keen to take on unusual tasks.

We will help you with those challenges that many others would give up on.