

Suspension-System profiPLUS 50

Type: Panel-coupling N, hanging

Material-No.: 142.30*.***
 142.300.250 (l= 250mm)
 142.300.500 (l= 500mm)
142.300.750 (l= 750mm)
 142.301.000 (l=1000mm)

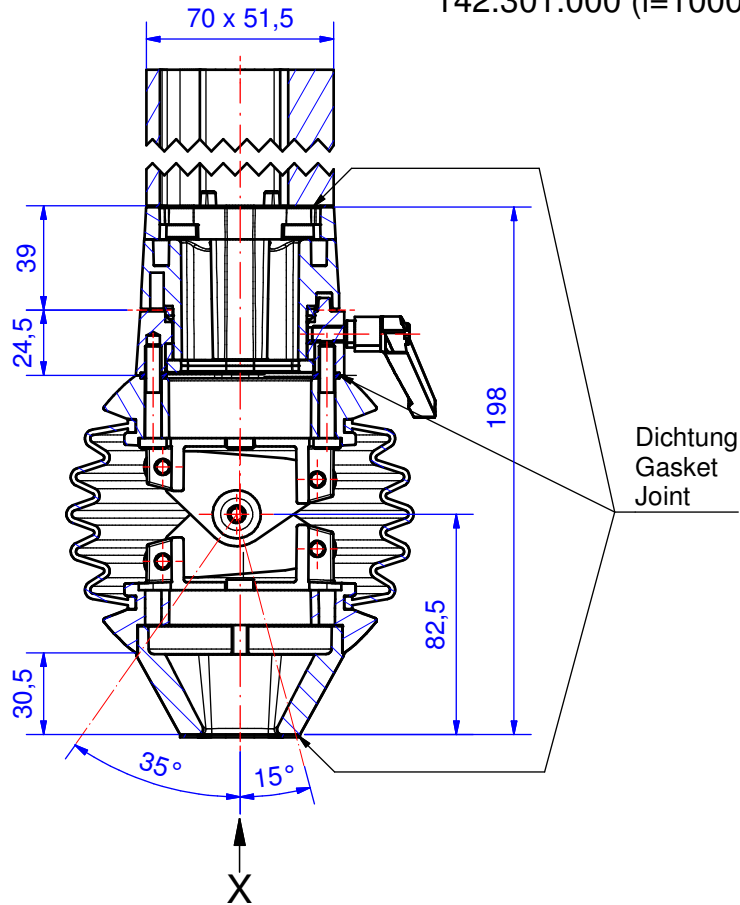

Dichtung
Gasket
Joint

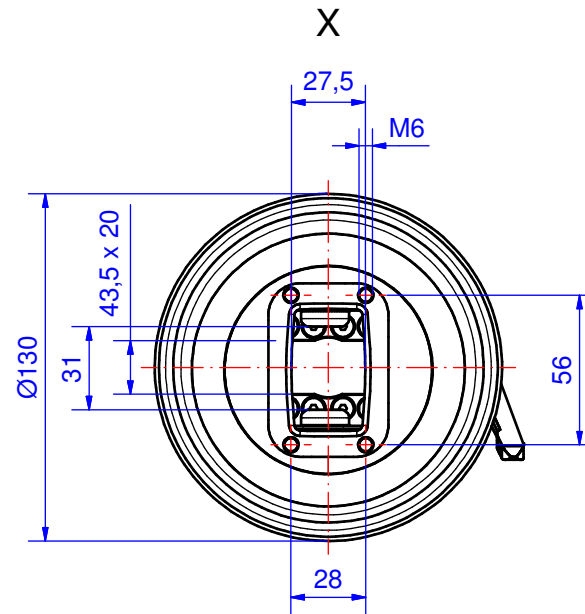

Suspension system material	GD-AI Si 12 (DIN 1706)		Bending range	310°
Profile material	Extruded aluminium		Weight	1.820 g + profile 3.600 g/m
Gasket	3x Chloroprene (CR), black		Surface	Powder coating RAL 7035, light grey
Mounting screws	4x M6, galvanized steel		Surface profile	Silver anodized
Ingress protection	IP54 EN 60529		Tolerance	GTA 13/5 DIN 1688-4 (outside dimensions ±0,8mm)

142.300.750
Panel coupling A, hanging 750 mm



Product overview

Material	Aluminium
Protection Class	IP 54/EN 60529
Color	RAL 7035, RAL 7016
Weight (g)	4520 g

profiPLUS 50

THE PREMIUM DESIGN SUPPORT ARM SYSTEM

IP 54

The key product features:

- System parts material: diecast aluminium, powder coating, RAL 7035
- Suspension profile material: aluminium profile, in anodised silver
- Whether profiPLUS 50 or 70: both systems offer sufficient space for cable routing
- Simple height adjustment with patented 'one screw adjustment'
- End-to-end potential equalisation to protect humans and equipment
- Many couplings with pre-fitted suspension profile as standard
- Can be used with all ROLEC control enclosures; the perfect complement to 'multiPANEL' and 'profiPANEL'
- Possible to route connectors such as HDMI, DVI, network adapters, etc.
- Integrated cable protection
- Gasket: chloroprene (CR)

Feel free to use our practical suspension arm configurator. Please choose whether you want a **HORIZONTAL or **VERTICAL** alignment.**

profiPLUS 50 is a modern suspension arm system which combines ergonomic design with advanced technology. The range includes mounting adapters for connecting to display panels from leading manufacturers such as Siemens, B&R and Beckhoff.

The profiPLUS 50 system is designed for time-saving assembly. For this, ROLEC engineers have developed the "one-screw adjustment" feature which means the system can be fully adjusted by just a single screw. All system couplings are pre-fitted with a support profile as standard, saving assembly time. The ducts in the interior of the system provide space for multiple cables such as HDMI, DVI and network cables. Cable protectors are integrated into all rotating system elements as standard. Fully integrated electrical bonding protects operators and the machinery. A set screw system in the joints allows adjustment of the pivoting range in 30° steps. For higher loads, a reducer adapter also enables connection of profiPLUS 50 to the larger **profiPLUS 70 system**.

Principle

Economic, compact and elegant designer suspension arm system for light to medium loads

Additional info

Possible to connect control enclosures from leading manufacturers such as Siemens, Beckhoff, B&R and ROLEC

The spacious cable routing offers an optimum connection with all interfaces, sufficient space is available for a range of cables and connectors

Patented ROLEC solution for alignment of the complete system in a horizontal direction through a single set screw!

Continuous equipotential bonding, DIN VDE 0113 / EN 60204-1 / IEC 204-1

All couplings are equipped with pre-fitted support profile as standard

Integrated cable protection in all system parts

Optional: Signal light adapters for joint and elbow

Material/coating

Diecast aluminium alloy, powder coated RAL 7035 light grey

Optional: Special colours

Support profiles: Extruded aluminium profile, anodised silver, preformed fastening thread

Optional: Anodised special colours or powder coated

Covers: Plastic (POM), RAL 7015 slate grey

Bellows: PVC-P, RAL 7016 anthracite grey, temperature resistance: -30°C to +70°C

Gasket

Chloroprene O-ring gasket (CR)

Cable routing

Suitable for HDMI, patch cables, DVI, USB, cold-device plugs etc.

Ingress protection

IP 54 / EN 60529

Customising

Learn more about our [full customising service for installation-ready enclosures](#)

Full-Service-Products

Customization according to your wishes.



Our passion is enclosures.



Expert advice

Everything begins with individual advice. We'll be pleased to support you with your project and find solutions for every requirement. Customer-specific solutions are our speciality.



Sample service

Test our products with your internal mounting. We'll be pleased to send you a sample enclosure for inspection with no strings attached.



Drilling

We'll manufacture every enclosure for you according to your exact specifications – whether they involve precise drilling or large tolerance.



Milling

Thanks to our modern CNC production, we can quickly and efficiently mill custom-fit cut-outs and contours to match your exact specifications.



Engraving

Our services also include engraving your logo and other elements, which we can of course perform in any colour you desire.



Lasering

We can process stainless steel enclosures and plates quickly and reliably according to your individual requirements thanks to our in-house lasering centre.



Powder coating

We can powder coat enclosures, command enclosures and suspension systems in any RAL colour you desire. Custom colours are of course also possible.



Painting

We can also paint all our enclosures in any RAL colour you desire. The application of primer and special colour structures are possible, as well.



Serigraphy

If desired, we can apply your logo and lettering or other markings using serigraph printing.



Digital printing

Digital printing is particularly worthwhile for low-volume orders and for realising complex patterns or images.



EMC enclosures

We offer our conFORM low-price standard EMC enclosure to protect your internal mounting against electromagnetic radiation. On request, we can also supply an EMC-compliant version of any other ROLEC enclosure.



Displays

We are able to offer the right made-to-measure display for all our enclosures – in varying sizes and degrees of robustness depending on the application.



Accessories

ROLEC's portfolio also includes matching front plates, mounting plate, supporting rails and terminal blocks as well as a range of cable glands, blanking plugs etc.



Assembly

Would you like to have all your components supplied already assembled? No problem. Our assembly team will be pleased to perform all assembly work on your behalf.



Our Service

If you have any requirements for services not listed here, please ask us. Customer-specific solutions are our speciality. We also are keen to take on unusual tasks.

We will help you with those challenges that many others would give up on.