

Suspension-System taraSMART

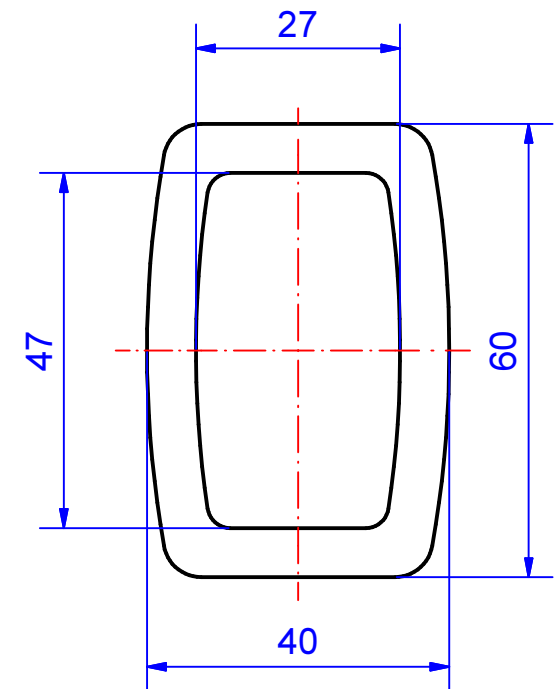

Type: Support profile

Material-No.:
144.500.250 (L= 250 mm)
144.500.500 (L= 500 mm)
144.500.750 (L= 750 mm)
144.501.000 (L= 1000 mm)

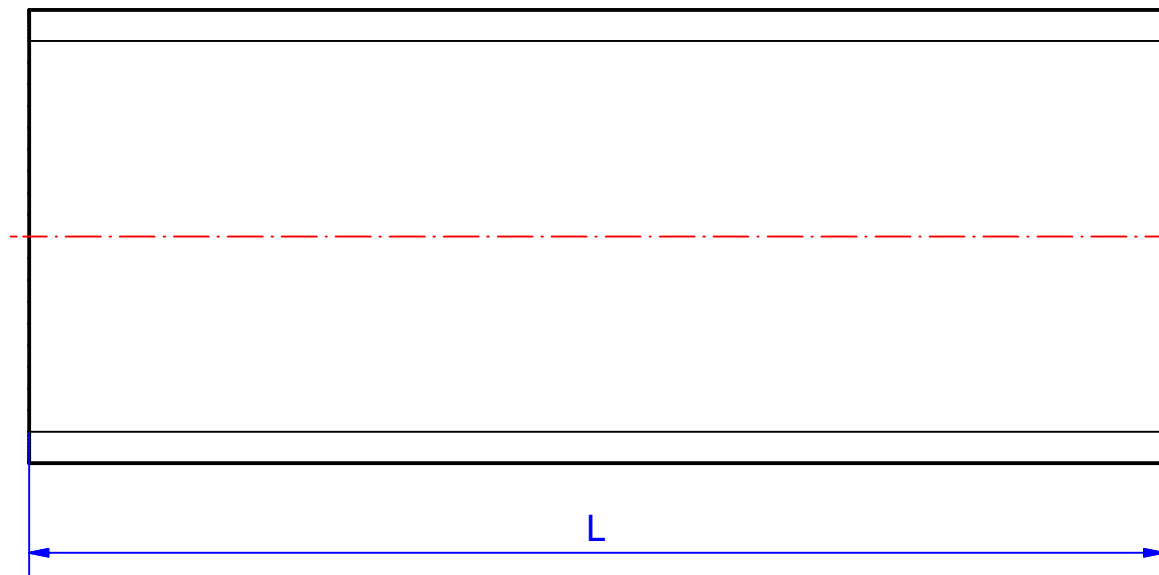

Material	Aluminium		Surface	Silver anodized
Weight	2,9 kg/ m		Tolerance	Linear dimension ± 1 mm, remaining dimensions DIN ISO 8015 EN 12020

144.500.250
Support profile 250 mm



Product overview

Material	Extruded aluminium
Protection Class	IP 54/EN 60529
Color	Anodised silver
Weight (g)	720 g

taraSMART

THE DESIGN SUPPORT ARM SYSTEM

IP 54

The key product features:

- System components: diecast aluminium, RAL 7035 light grey
- Covers: thermoplast, RAL 7016, anthracite grey
- Support profiles: extruded aluminium, rectangular and round tube □ 48 mm, silver anodised
- Can be used with all ROLEC control enclosures
- Possible to route connectors such as HDMI, patch cable, USB, etc.
- Gasket: Chloroprene (CR)

taraSMART is a sophisticated suspension arm system for modern machine construction. The perfect symbiosis of technical design and sophistication. It offers sufficient space for routing HDMI or DVI cables, or network plugs. Installation is quick and easy, thanks to the familiar, tried and tested technology. The coupling variants of the system enable the connection of both narrow and deep control enclosures. Thanks to the Ø48 bracket, the straightforward connection of panel PCs with a round tube frame can take place without additional adapters.

To configure this product, please [contact us without obligation. We are happy to help.](#)

Principle

Economic, compact and elegant designer suspension arm system for light to medium loads

Additional information

Connection of HMI/control enclosures from leading manufacturers with a round tube frame (such as Siemens, Beckhoff, B&R) possible

The generous cable routing offers an optimum connection with all interfaces, sufficient space is available for a range of cables and connectors

Horizontal alignment of the complete system assembly possible at all joints!

Material/coating

Die-cast aluminium alloy, powder coated RAL 7035 light grey

Optional: Special colours

Support profiles: Extruded aluminium profile, silver anodised

Ø48 round tubes: steel, silver coated

Covers: Thermoplast, RAL 7016, anthracite grey

Gasket

Chloroprene O-ring gasket (CR)

Cable routing

Suitable for HDMI, patch cables, DVI, USB, cold-device plugs, etc.

Ingress protection

IP 54 / EN 60529

ROLEC service

Avail of our [Full Service Offer for installation-ready products](#)

Configuration

If you have any questions or require individual configuration, your [field service contact](#) will be happy to assist

Full-Service-Products

Customization according to your wishes.



Our passion is enclosures.



Expert advice

Everything begins with individual advice. We'll be pleased to support you with your project and find solutions for every requirement. Customer-specific solutions are our speciality.



Sample service

Test our products with your internal mounting. We'll be pleased to send you a sample enclosure for inspection with no strings attached.



Drilling

We'll manufacture every enclosure for you according to your exact specifications – whether they involve precise drilling or large tolerance.



Milling

Thanks to our modern CNC production, we can quickly and efficiently mill custom-fit cut-outs and contours to match your exact specifications.



Engraving

Our services also include engraving your logo and other elements, which we can of course perform in any colour you desire.



Lasering

We can process stainless steel enclosures and plates quickly and reliably according to your individual requirements thanks to our in-house lasering centre.



Powder coating

We can powder coat enclosures, command enclosures and suspension systems in any RAL colour you desire. Custom colours are of course also possible.



Painting

We can also paint all our enclosures in any RAL colour you desire. The application of primer and special colour structures are possible, as well.



Serigraphy

If desired, we can apply your logo and lettering or other markings using serigraph printing.



Digital printing

Digital printing is particularly worthwhile for low-volume orders and for realising complex patterns or images.



EMC enclosures

We offer our conFORM low-price standard EMC enclosure to protect your internal mounting against electromagnetic radiation. On request, we can also supply an EMC-compliant version of any other ROLEC enclosure.



Displays

We are able to offer the right made-to-measure display for all our enclosures – in varying sizes and degrees of robustness depending on the application.



Accessories

ROLEC's portfolio also includes matching front plates, mounting plate, supporting rails and terminal blocks as well as a range of cable glands, blanking plugs etc.



Assembly

Would you like to have all your components supplied already assembled? No problem. Our assembly team will be pleased to perform all assembly work on your behalf.



Our Service

If you have any requirements for services not listed here, please ask us. Customer-specific solutions are our speciality. We also are keen to take on unusual tasks.

We will help you with those challenges that many others would give up on.