

# Enclosure series aluDISC

Type: AR 100

Material-No.: 280.100.000

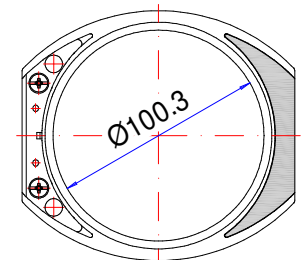
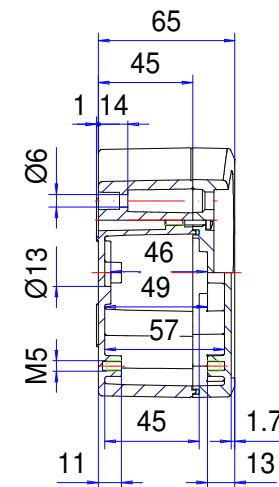
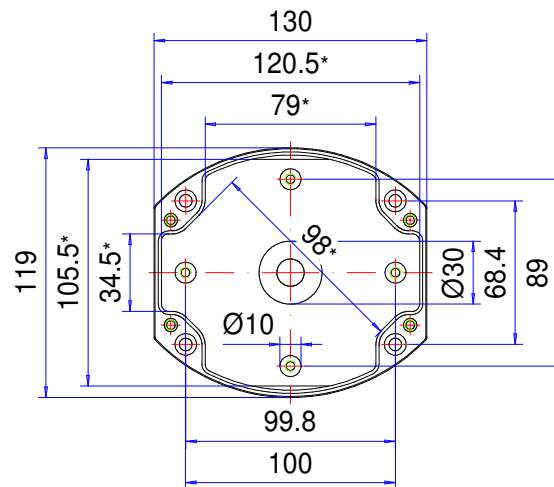
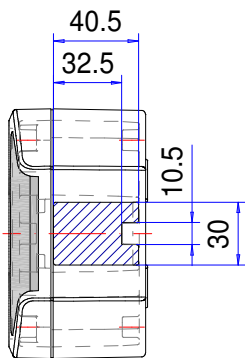
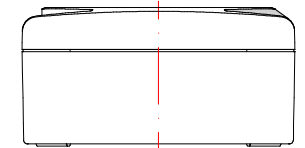
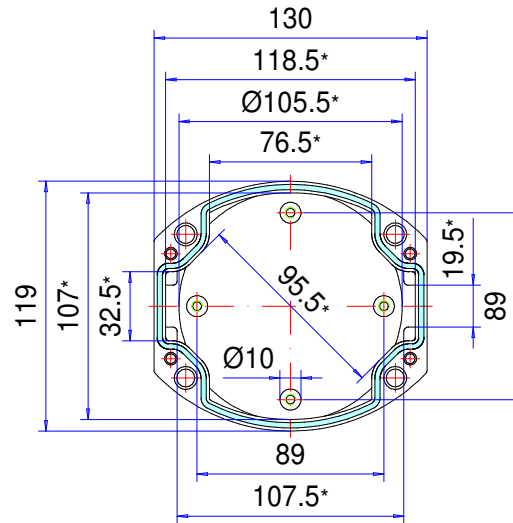

Folie/ Keypad  
Ø99.7<sup>+0</sup><sub>-0.2</sub>

\* Please note: Mould slope for casting ejection, dimensions in the amount of the bottom!

Enclosure material	EN AC-44300 (DIN EN 1706)		Ingress protection	IP66/67 EN 60529
Lid screws	4x stainless steel 1.4567 (V2A), captive		Weight	610 g
Assembly screws	5x M5x8, galvanized steel		Coating	Powder coating RAL 7035, light grey
Design covers	2x Polyoxymethylene (POM), RAL 7016, anthracite grey		Tolerance	DIN CEN ISO/TS 8062-2 (outside dimensions ±0,5mm)
Gasket	1x moulded gasket, silicone, red			

**280.100.000**  
**aluDISC AR 100**



**Product overview**

Material	Aluminium
Protection Class	IP 66/67 EN 60529, IP 69K
Color	RAL 7035
Certifications	CSA (optional), UL (optional)
Length (L)	130 mm
Width (W)	119 mm
Height (H)	65 mm
Weight (g)	590 g

## aluDISC

### THE ROUND ELECTRONICS ENCLOSURES

#### IP 66, IP 67 - Optional: IP 69K

##### The key product features:

- Enclosure material: diecast aluminium
- Enclosure surface: powder coating, RAL 7035
- Clip-on design covers
- The enclosure can be fastened when the cover is fitted
- Integrated recess to accommodate membrane keypad or front plate
- Lid screws in stainless steel 1.4567
- Enclosure seal: silicone moulded gasket

---

aluDISC is the world's first round diecast aluminium enclosure for industrial electronics. The unique design integrates perfectly with machinery and piping systems. No matter if it is mounted on a wall, to a pipe system or a machine housing, the round aluDISC shape will always make a great impression.

Standard features include IP 66 and IP 67 protection classes, a recessed lid for fitting a membrane keypad or product label, snap-on design covers which hide the lid screws and mounting holes, lid retaining straps, an optional hinged IP 65 transparent cover and screw bosses in the base and lid for fitting PCBs, mounting plates etc. The enclosures can be mounted without opening the lid which means your electronics remain protected at all times. Matching cable glands and other accessories are also available.

We can supply aluDISC enclosures fully customised to your requirements.

#### Enclosure sizes

4

#### Additional info

Integrated recess in the lid for a membrane keypad, front plate or label

For AR 120: Optional protective cover with hinge mechanism made from transparent polycarbonate (PC), UV stabilised, UL 94 V-2 – 0,36 ~ 1,9 mm, HB > 1,9 mm, sealable

Clip-on design covers, plastic POM (polyoxymethylene), similar to RAL 7016 anthracite grey

Optional: Lid support, lid screw with plastic element made from stainless steel 1.4567 and polyamide (PA6)

#### Enclosure

Diecast aluminium alloy

EN AN-44300 DIN EN 1706

(GD Al Si 12/DIN 1725)

1° mould slope for casting ejection > internal circumference dimensions decrease by 1° towards enclosure bottom.

#### Fastening

Separate screw channels

### **Internal mounting**

Fastening thread on the enclosure base and in the lid

### **Ingress protection**

IP 66, IP 67 / EN 60529

Optional: IP 69K / ISO 20653

### **Gasket**

Silicone moulded gasket

Optional: Chloroprene O-ring gasket (CR)

### **Lid screws**

Stainless steel 1.4567, captive

### **Surface**

Powder coating RAL 7035, light grey

Optional: Special colours

Optional: Corrosion protection

### **Customising**

Learn more about our [full customising service for installation-ready enclosures](#)

# Full-Service-Products

Customization according to your wishes.



Our passion is enclosures.



Expert advice

Everything begins with individual advice. We'll be pleased to support you with your project and find solutions for every requirement. Customer-specific solutions are our speciality.



Sample service

Test our products with your internal mounting. We'll be pleased to send you a sample enclosure for inspection with no strings attached.



Drilling

We'll manufacture every enclosure for you according to your exact specifications – whether they involve precise drilling or large tolerance.



Milling

Thanks to our modern CNC production, we can quickly and efficiently mill custom-fit cut-outs and contours to match your exact specifications.



Engraving

Our services also include engraving your logo and other elements, which we can of course perform in any colour you desire.



Lasering

We can process stainless steel enclosures and plates quickly and reliably according to your individual requirements thanks to our in-house lasering centre.



Powder coating

We can powder coat enclosures, command enclosures and suspension systems in any RAL colour you desire. Custom colours are of course also possible.



Painting

We can also paint all our enclosures in any RAL colour you desire. The application of primer and special colour structures are possible, as well.



Serigraphy

If desired, we can apply your logo and lettering or other markings using serigraph printing.



Digital printing

Digital printing is particularly worthwhile for low-volume orders and for realising complex patterns or images.



EMC enclosures

We offer our conFORM low-price standard EMC enclosure to protect your internal mounting against electromagnetic radiation. On request, we can also supply an EMC-compliant version of any other ROLEC enclosure.



Displays

We are able to offer the right made-to-measure display for all our enclosures – in varying sizes and degrees of robustness depending on the application.



Accessories

ROLEC's portfolio also includes matching front plates, mounting plate, supporting rails and terminal blocks as well as a range of cable glands, blanking plugs etc.



Assembly

Would you like to have all your components supplied already assembled? No problem. Our assembly team will be pleased to perform all assembly work on your behalf.



Our Service

If you have any requirements for services not listed here, please ask us. Customer-specific solutions are our speciality. We also are keen to take on unusual tasks.

We will help you with those challenges that many others would give up on.