

type PPD 90 standard 520x520

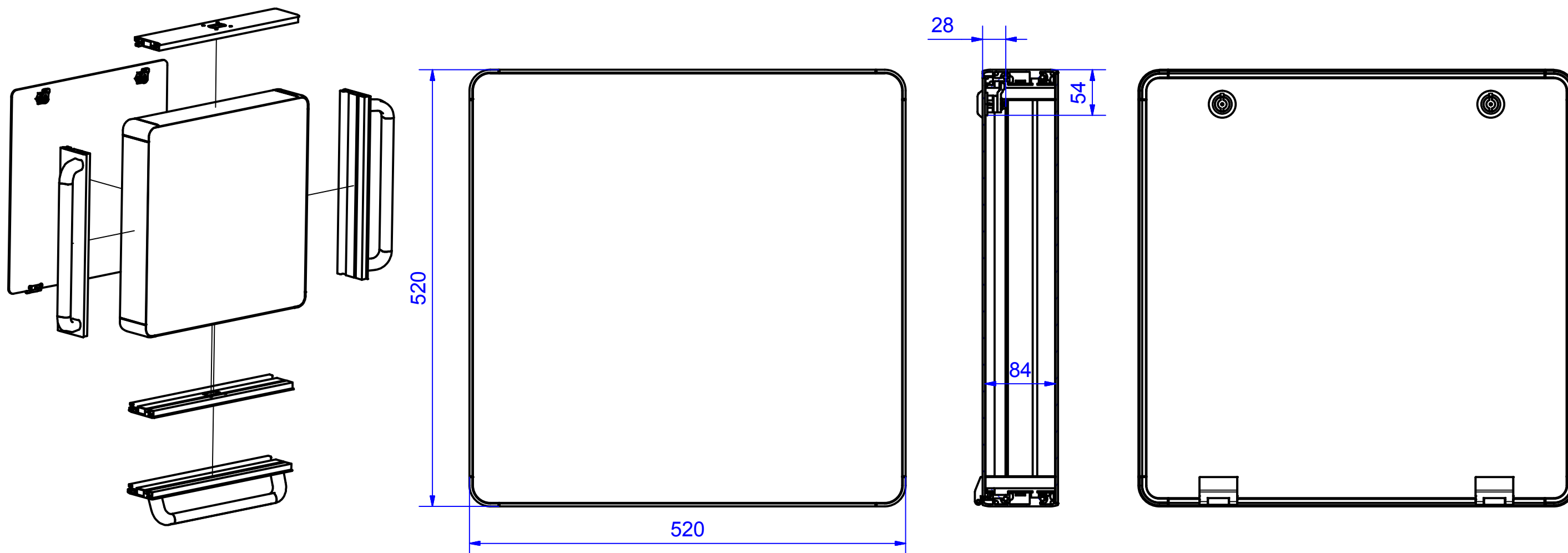

useable front-plate area= 470x470 mm  
 area reduction generated by lock and hinge combination

- optional
- unmachined
  - with coupling cutout on top or bottom
  - with profile side handles left and right or on the bottom

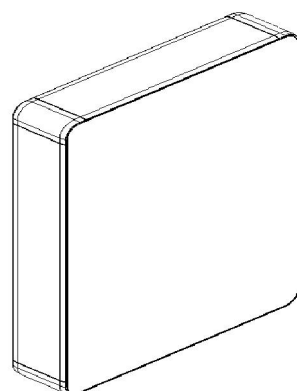
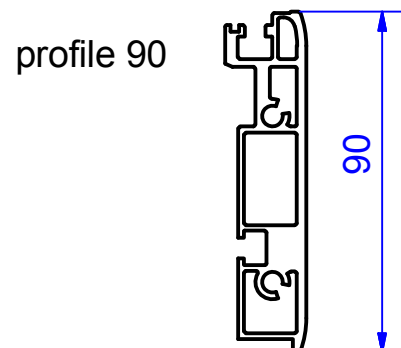

enclosure material	aluminium profile (AlMgSi0,5) anodized , corner (AlSi 12)		front panel	aluminium 3mm, anodized
rear panel	hinges and lock		corner covers	PA RAL 7035
protection class	IP65 EN 60529		tolerances	outside dimension +/-1mm; others DIN 2768-m

**331.090.003**  
**profiPANEL Standard 15"-17"**



**Product overview**

Material	Extruded aluminium
Protection Class	IP 65/ EN 60529
Color	Anodised silver, RAL 7035
Certifications	UL (optional)
Length (L)	520 mm
Width (W)	520 mm
Height (H)	90 mm

## profiPANEL Standard

### THE DESIGN HMI ENCLOSURE IN STANDARD SIZES

#### Up to IP 65

#### The key product features:

- Enclosure material: aluminium profiles corner covers, RAL 7035
- Enclosure surface: anodised silver
- Available in 4 Standard Sizes
- Installation depths: 90 mm
- Select enclosure dimensions based on the planned internal mountings
- Define the machining of the front plate required
- Define the position of the suspension arm fixing
- On request, select pro handle(s). Possible on the side or at the bottom of the enclosure
- Enclosure seal: PUR

---

The economical version of the HMI/control enclosure range with a depth of 90 mm. For everyone in a rush, who requires only a small batch size or who does not need millimetre-precise dimensions: "We have developed the "profiPANEL Standard" for these customers. Four standard sizes from a 90 mm basic profile with individually configurable front plate into which every panel PC and additional buttons or switches can be incorporated. The rear wall (on the longer side of the enclosure) features locks and hinges. profiPANEL Standard is quickly available and inexpensive.

To configure this product, please [contact us without obligation. We are happy to help.](#)

The benefits of "profiPANEL Standard" at a glance:

- Four economical standard sizes to fit panel PCs up to 21"
- Inexpensive alternative due to standardisation
- Shorter delivery times as components are held in stock
- Customised machining of the front plate
- Also ideal for smaller order volumes
- Ingress protection IP 65

**Just 4 simple steps to a perfectly coordinated, economical control enclosure:** Select enclosure dimensions based on the planned internal mounting. Define the machining of the front plate required. Define the position of the suspension arm fixing. Select optional handle(s). Side or bottom only available.

#### Enclosure sizes

Four standard sizes

L x W x H 400 x 400 x 90 mm for internal mountings from 10" to 12"

L x W x H 400 x 520 x 90 mm for internal mountings from 12" to 15"

L x W x H 520 x 520 x 90 mm for internal mountings from 15" to 17"

L x W x H 520 x 600 x 90 mm for internal mountings from 17" to 21"

### **Further information**

Minimalist, multi-variable design for modern machines

Front plate is permanently connected to the enclosure, mounted almost edgeless and flush

### **Enclosure**

Extruded aluminium

PA corner covers, RAL 7035, 9005, 3020 or 5017

Standard front plates: Aluminium 3 mm, Al Mg 1, silver anodised

Finished front plates, lasered, engraved or printed

Optional: Profile handle, PA, RAL 7035 and extruded aluminium

Enclosure lock (standard): Locks and exterior hinges (on the longer side of the enclosure)

### **Fastening**

With coupling on the ROLEC [suspension arm system profiPLUS 50](#)

### **Internal mountings**

Slide-in contours for spring nuts M4/M5

### **Ingress protection**

IP 65 / EN 60529

### **Surface**

Anodised

### **ROLEC Service**

Utilise our [full service offer for installation-ready enclosures](#)

# Full-Service-Products

Customization according to your wishes.



Our passion is enclosures.



Expert advice

Everything begins with individual advice. We'll be pleased to support you with your project and find solutions for every requirement. Customer-specific solutions are our speciality.



Sample service

Test our products with your internal mounting. We'll be pleased to send you a sample enclosure for inspection with no strings attached.



Drilling

We'll manufacture every enclosure for you according to your exact specifications – whether they involve precise drilling or large tolerance.



Milling

Thanks to our modern CNC production, we can quickly and efficiently mill custom-fit cut-outs and contours to match your exact specifications.



Engraving

Our services also include engraving your logo and other elements, which we can of course perform in any colour you desire.



Lasering

We can process stainless steel enclosures and plates quickly and reliably according to your individual requirements thanks to our in-house lasering centre.



Powder coating

We can powder coat enclosures, command enclosures and suspension systems in any RAL colour you desire. Custom colours are of course also possible.



Painting

We can also paint all our enclosures in any RAL colour you desire. The application of primer and special colour structures are possible, as well.



Serigraphy

If desired, we can apply your logo and lettering or other markings using serigraph printing.



Digital printing

Digital printing is particularly worthwhile for low-volume orders and for realising complex patterns or images.



EMC enclosures

We offer our conFORM low-price standard EMC enclosure to protect your internal mounting against electromagnetic radiation. On request, we can also supply an EMC-compliant version of any other ROLEC enclosure.



Displays

We are able to offer the right made-to-measure display for all our enclosures – in varying sizes and degrees of robustness depending on the application.



Accessories

ROLEC's portfolio also includes matching front plates, mounting plate, supporting rails and terminal blocks as well as a range of cable glands, blanking plugs etc.



Assembly

Would you like to have all your components supplied already assembled? No problem. Our assembly team will be pleased to perform all assembly work on your behalf.



Our Service

If you have any requirements for services not listed here, please ask us. Customer-specific solutions are our speciality. We also are keen to take on unusual tasks.

We will help you with those challenges that many others would give up on.