

type PPD 150 (90/60)

article-no.: 332.150.AAA

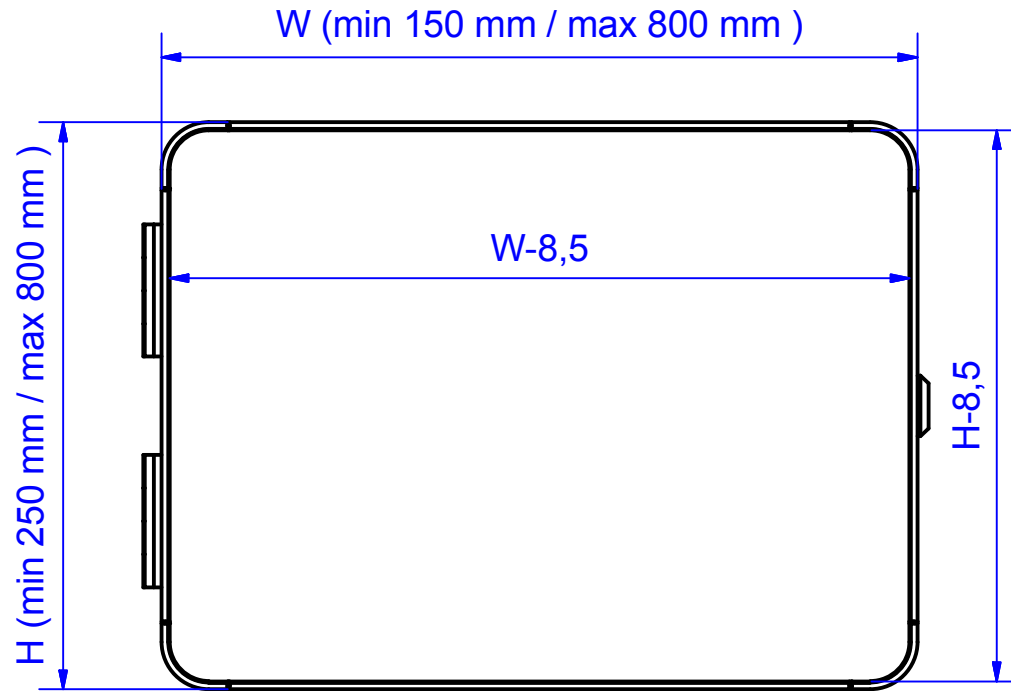

front

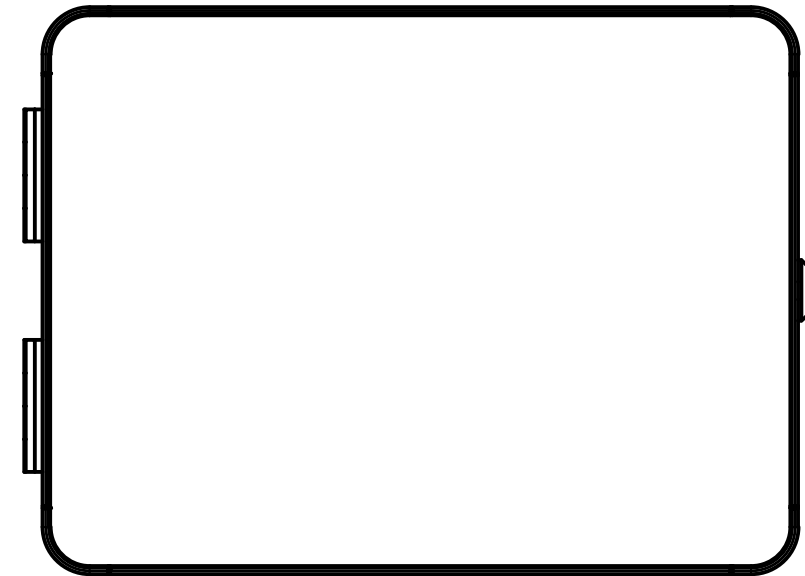
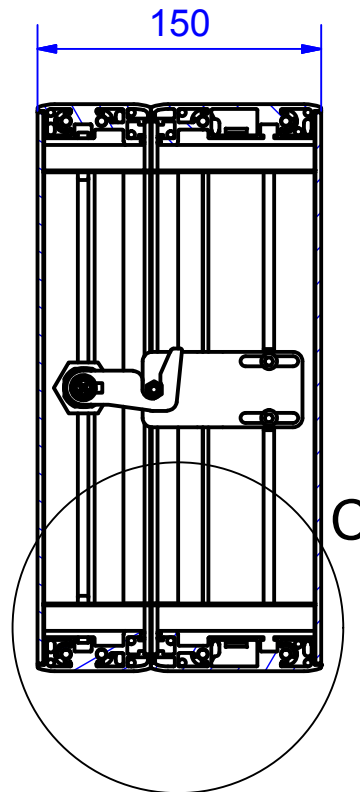

door

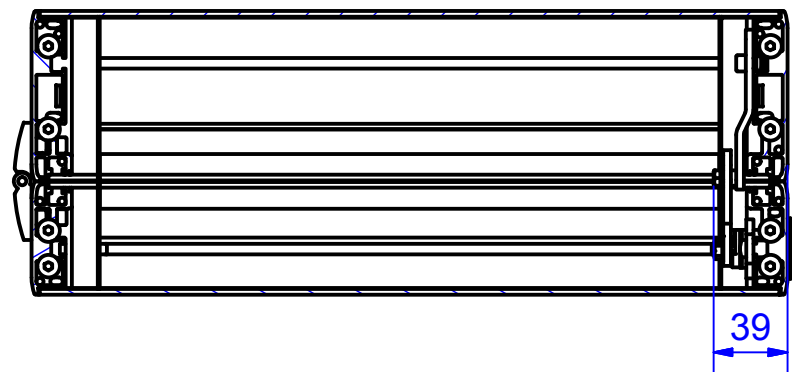

useable front-plate area= nominal size -50 mm
 area reduction generated by lock and hinge combination

*1 lock on side for dimension H < 600 mm
 2 locks on side for dimension H ≥ 600mm
 (distance between locks= H-300mm)

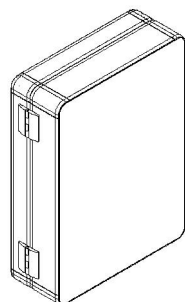
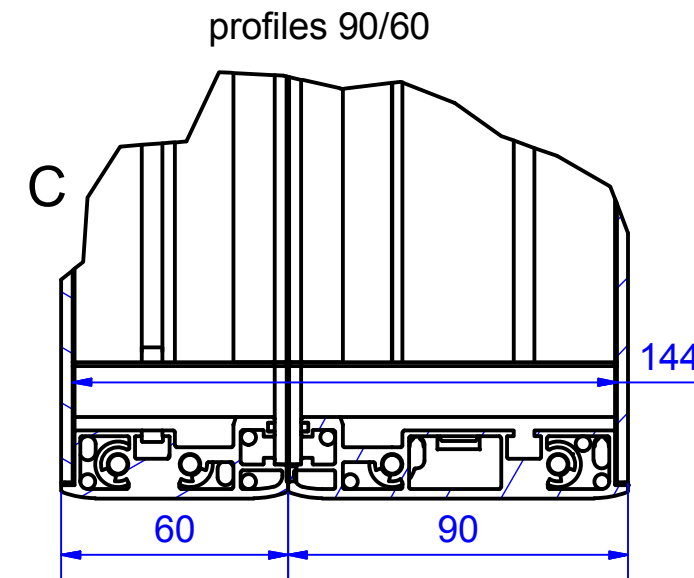

enclosure material	aluminium profile (AlMgSi0,5) anodized , corner (AlSi 12)	front panel	aluminium 3mm, anodized
door	hinges and locks	corner covers	PA RAL 7035
protection class	IP65 EN 60529	tolerances	outside dimension+/-1mm; others DIN 2768-m
weight	depends on configuration		

332.150.001
PPD 150 (Combi 90/60)



Product overview

Material	Extruded aluminium
Protection Class	IP 65/ EN 60529
Color	Anodised silver, RAL 7035
Certifications	UL (optional)

profiPANEL

THE DESIGN HMI ENCLOSURE

(UL approval not valid for panels with basic profile 120)

Up to IP 65

The key product features:

- Enclosure material: aluminium profiles
- Enclosure surface: anodised silver
- Corner cover: RAL 7035
- Profile enclosure – manufactured to measure in 9 installation depths
- Direct access through doors with locks and hinges (on the longer side as standard)
- Enclosure seal: PUR

Thanks to the option of combining all basic profile depths, profiPANEL enables a total of nine mounting depths to be provided for. The connection of 60 or 90 mm deep desk also offers additional options for extended internal mounting. Thanks to this wide range of depths, profiPANEL therefore enables almost every conceivable configuration for the internal mounting of components to be realised. The enclosure front of the profiPANEL system is manufactured made-to-measure and provides for the almost edgeless and flush mounting of a front plate, which is permanently connected to the enclosure. Appropriate cut-outs for a display, switches and more are included in the service provided by ROLEC and are produced ex-works to meet customer specifications. A desk is a clever solution when there's not enough space in the control enclosure or you need additional buttons. The profiPANEL series therefore includes two desk models, 60 and 90 mm deep (D), for internal mounting. The desk adapter offers plenty of space for routing HDMI or DVI cables or network plugs. The desk is 200 mm high ex works. Non-standard dimensions are available on request. The rear wall of the desk is bolted on as standard. An ergonomically designed profile handle system is available for even more convenient handling, particularly with the deeper profile versions. There is also a 450-mm wide latching keyboard holder as an alternative to the desk, which can be enhanced and/or extended by an additional mouse holder.

To configure this product, please [contact us without obligation. We are happy to help.](#)

Enclosure sizes

Made-to-measure as per customer's needs

L x W x H max. 150 x 150 x 360 mm

800 x 800 x 60-300 mm

Additional information

Minimalist, multi-variable design for modern machines

Profile enclosure – made-to-measure

Four basic profiles (60/90/120/150 mm). Nine enclosure depths: 60/90/120/150/180/210/240/270/300 mm

Front plate is permanently connected to the enclosure, mounted almost edgeless and flush

Enclosure

Extruded aluminium

Thermoplast corner covers, RAL 7035, 9005, 3020 or 5017

Standard front plates: aluminium 3 mm, Al Mg 1, silver anodised

Optional: Finished front plates, lasered, engraved or printed

Optional: Profile handle, extruded aluminium with plastic connection, RAL 7035

Enclosure lock Basic profiles: locks and exterior hinges, optionally bolted

Enclosure lock profile combinations: locks and exterior hinges

<https://rolec-enclosures.co.uk>



Our passion is enclosures.

Fastening

Basic profile with panel coupling, all other profiles with coupling on the ROLEC **suspension arm system**
profiPLUS 50

Internal mounting

Slide-in contour for spring nuts M4/M5

Ingress protection

Up to IP 65 / EN 60529

Coating

Anodised

ROLEC service

Avail of our **Full Service Offer for installation-ready enclosures**

Full-Service-Products

Customization according to your wishes.



Our passion is enclosures.



Expert advice

Everything begins with individual advice. We'll be pleased to support you with your project and find solutions for every requirement. Customer-specific solutions are our speciality.



Sample service

Test our products with your internal mounting. We'll be pleased to send you a sample enclosure for inspection with no strings attached.



Drilling

We'll manufacture every enclosure for you according to your exact specifications – whether they involve precise drilling or large tolerance.



Milling

Thanks to our modern CNC production, we can quickly and efficiently mill custom-fit cut-outs and contours to match your exact specifications.



Engraving

Our services also include engraving your logo and other elements, which we can of course perform in any colour you desire.



Lasering

We can process stainless steel enclosures and plates quickly and reliably according to your individual requirements thanks to our in-house lasering centre.



Powder coating

We can powder coat enclosures, command enclosures and suspension systems in any RAL colour you desire. Custom colours are of course also possible.



Painting

We can also paint all our enclosures in any RAL colour you desire. The application of primer and special colour structures are possible, as well.



Serigraphy

If desired, we can apply your logo and lettering or other markings using serigraph printing.



Digital printing

Digital printing is particularly worthwhile for low-volume orders and for realising complex patterns or images.



EMC enclosures

We offer our conFORM low-price standard EMC enclosure to protect your internal mounting against electromagnetic radiation. On request, we can also supply an EMC-compliant version of any other ROLEC enclosure.



Displays

We are able to offer the right made-to-measure display for all our enclosures – in varying sizes and degrees of robustness depending on the application.



Accessories

ROLEC's portfolio also includes matching front plates, mounting plate, supporting rails and terminal blocks as well as a range of cable glands, blanking plugs etc.



Assembly

Would you like to have all your components supplied already assembled? No problem. Our assembly team will be pleased to perform all assembly work on your behalf.



Our Service

If you have any requirements for services not listed here, please ask us. Customer-specific solutions are our speciality. We also are keen to take on unusual tasks.

We will help you with those challenges that many others would give up on.