

144.340.250
Round tube Ø70 Beckhoff 250 mm

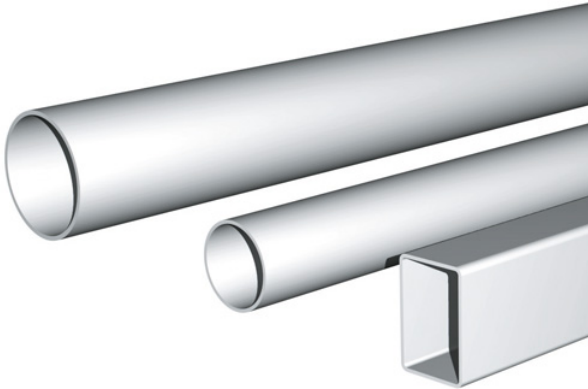

technical data

Protection class	IP 54/EN 60529
Colour	White aluminium RAL 9006
Certifications	GOST
Weight (g)	1725 g
Country of manufacture	Germany
Customs tariff number	73089098

taraPLUS Beckhoff

MULTIVARIABLE SUSPENSION ARM SYSTEM FOR BECKHOFF DISPLAY PANELS

IP 54

taraPLUS Beckhoff was developed for light to medium loads and specifically for fitting Beckhoff display panels. It is quick and easy to assemble on site and the large openings in the system parts allow cables to be easily fed through. The special Beckhoff design combines round and square profiles, thereby achieving high static equilibrium. taraPLUS is a tried and trusted system with ingress protection of IP 54.

Load-bearing capacity

embed_LBC_diagram_start_#etc/traglast/Belastungsdiagramm_Tara_EN.jpg#embed_LBC_diagram_end

Principle

Many variants, closed system with easy access to system parts for light to medium loads

Additional info

Simple alignment of the system

Easy installation of the cables

Special design due to the combination of rectangular and round tubes

Material/coating

System elements: Die-cast aluminium

EN AN-44300 DIN EN 1706

(GD Al Si 12/DIN 1725)

Powder coating RAL 7031, blue grey

Optional: Special colours

Suspension pipes: Fe

Powder coating RAL 9006, white aluminium

Optional: Special colours

Bellows: PVC, RAL 7035, light grey

Cable routing
48 mm pipe = 42 mm Ø

70 mm pipe = 62 mm Ø

60/40 mm pipe = 54 x 34 mm

Ingress protection
IP 54 EN 60529

Torque for cutting ring screws
30 Nm = 3 kg/m



<https://www.rolec-enclosures.co.uk>



Our *passion* is enclosures.

Suspension system taraPLUS

Type: Round tube Ø70

Material-No.: 144.34*.***

144.340.250 (L= 250 mm)

144.340.500 (L= 500 mm)

144.341.000 (L= 1000 mm)

144.341.500 (L= 1500 mm)

144.342.000 (L= 2000 mm)

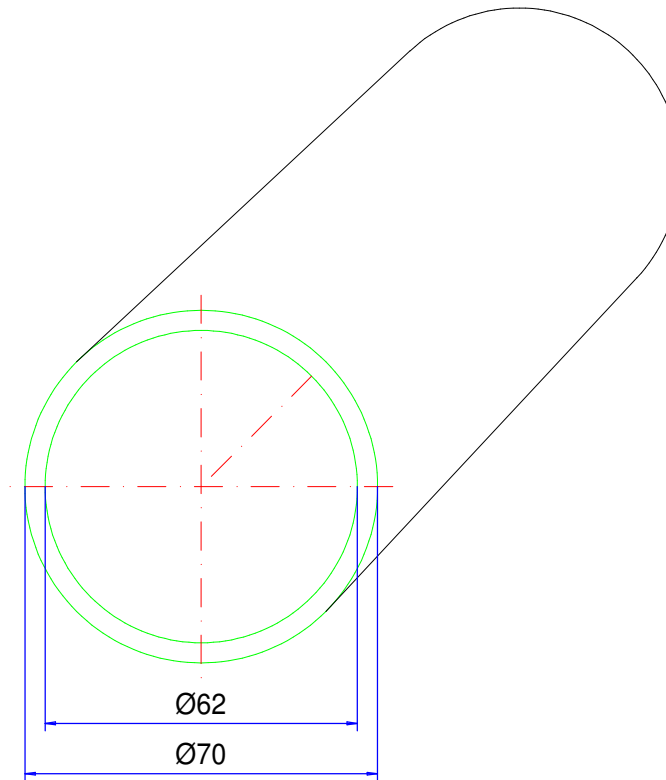

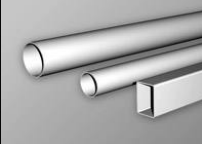
Material system elements	Steel, seamless, cold-drawn		Pivoting range	---
Gasket	---		Weight	6,900 kg/ m
Assembly screws	---		Coating	Powder coating RAL 9006, white aluminium
Ingress protection	IP54 EN 60529		Tolerance	EN 10305-4 (DIN 2391)