

245.202.000
inoBOX IB 202



technical data

Material	Stainless steel
Protection class	IP 66/EN 60529
Colour	Stainless steel edelstahl
Certifications	CSA (optional), GOST, UL (optional)
Length	300 mm
Width	200 mm
Height	120 mm
Weight (g)	2900 g
Country of manufacture	Germany
Customs tariff number	73269098

inoBOX A2

INNOVATIVE A2 STAINLESS STEEL ENCLOSURE TO PROTECT VALUABLE INTERIORS

IP 66

inoBOX 1.4301/A2 stainless steel enclosures impress with the usual ROLEC benefits - for every type of industrial internal mounting. Spacers are fitted in the bottom for mounting circuit boards, supporting rails or mounting plates. There is also an earthing bolt attached to the lid. Cable glands, mounting plates and other accessories are also available. For smaller order volumes, processing is carried out in our in-house laser processing centre. This offers maximum flexibility in the processing of products required at short notice.

Enclosure sizes
14 versions

Dimensions L x W x H:

100 x 100 x 90 mm to 400 x 300 x 120 mm

Further information

1.4301/A2, international designation: AISI 304

Enclosure

Stainless sheet steel, edged and welded, alloy 1.4301 (AISI 304) V2A, sheet thickness 1.2 mm

Fastening

Optional external fastening available

Internal mountings

Fastening points for mounting cross rails and mounting plates in the bottom

Earthing bolt M5 in the lid

Ingress protection

IP 66 / EN 60529

NEMA 4X

IK08 EN 62262

Gasket

Polyurethane (PU), temperature resistance - 40°C to + 80°C

Lid screws



<https://www.rolec-enclosures.co.uk>



Our *passion* is enclosures.

Stainless steel, captive, cross slot

Surface
Polished

ROLEC Service
Utilise our full service offer for installation-ready enclosures

Enclosure series inoBOX

Type: IB 202

Material-No.: 245.202.000

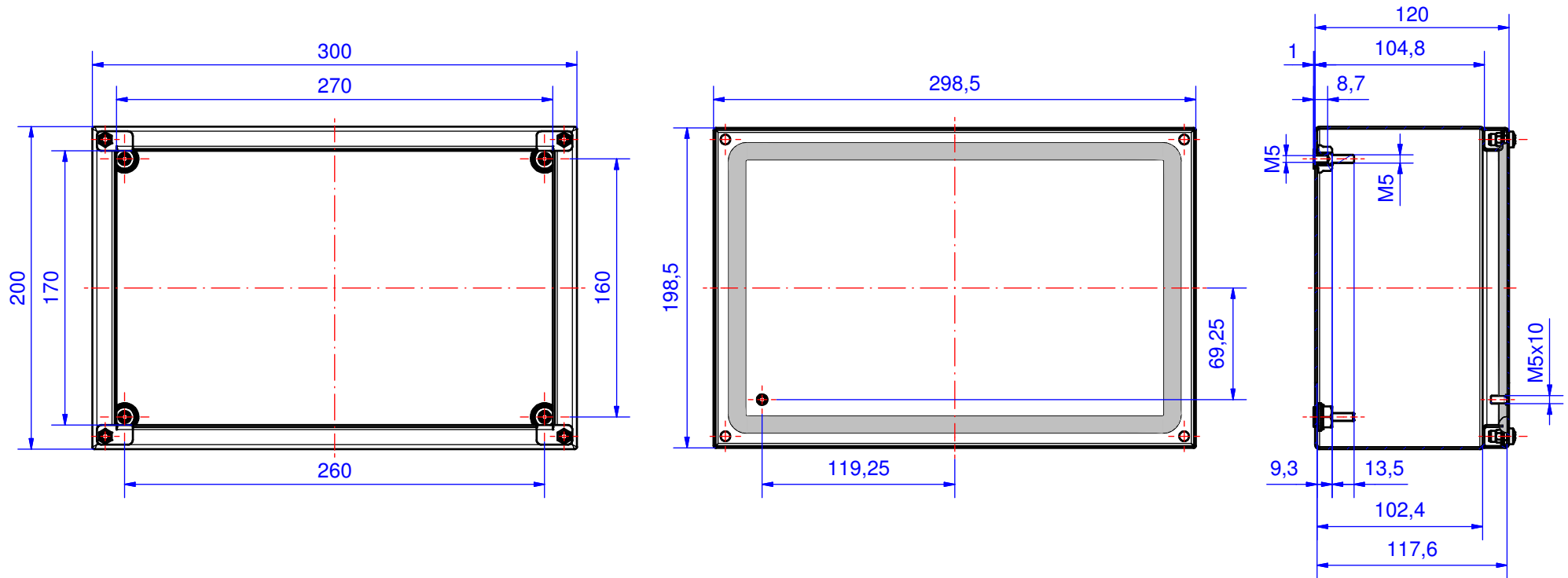

Enclosure material	V2A, 1.4301 (AISI 304)		Weight	2,9 kg
Lid screws	4x V2A, captive		Sheet thickness	1,2 mm
Gasket	Polyurethane, dosed gasket		Surface	Grinded, Scotch-Brite
Ingress protection	IP66 EN 60529		Tolerance	DIN ISO 2768-m DIN 6935