

Suspension-System profiPLUS 50

Type: Coupling N, standing

Material-No.: 142.26*.***
 142.260.250 (l= 250mm)
 142.260.500 (l= 500mm)
142.260.750 (l= 750mm)
 142.261.000 (l=1000mm)

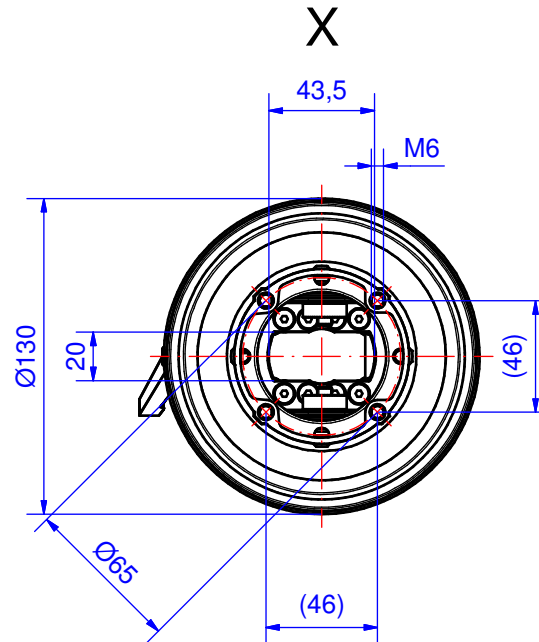
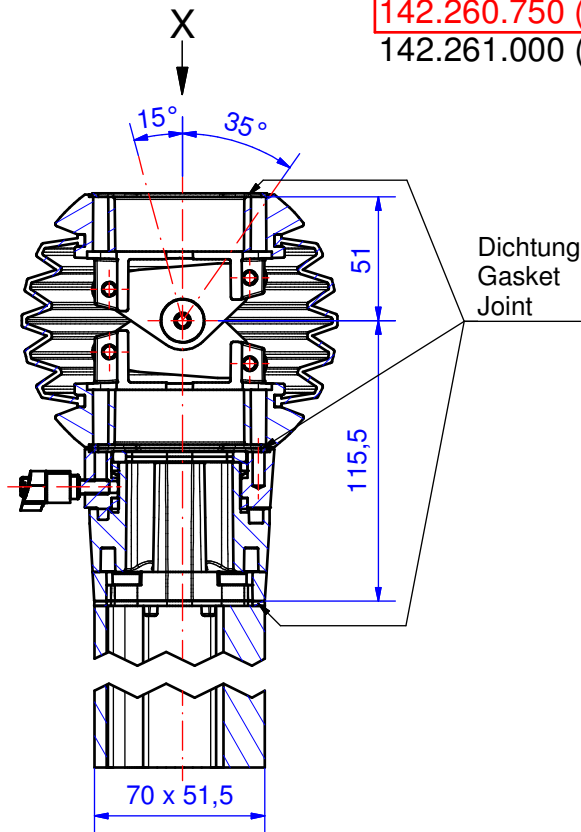

Suspension system material	GD-Al Si 12 (DIN 1706)		Bending range	310°
Profile material	Extruded aluminium		Weight	1.620 g + profile 3.600 g/m
Gasket	3x Chloroprene (CR), black		Surface	Powder coating RAL 7035, light grey
Mounting screws	4x M6, galvanized steel		Surface profile	Silver anodized
Ingress protection	IP54 EN 60529		Tolerance	GTA 13/5 DIN 1688-4 (outside dimensions ±0,8mm)