

Suspension-system Quadro 50

Type: Square tube 50x50

Material-No.: 144.02*.***

144.020.500 (L= 500 mm)

144.021.000 (L= 1000 mm)

144.021.500 (L= 1500 mm)

144.022.000 (L= 2000 mm)

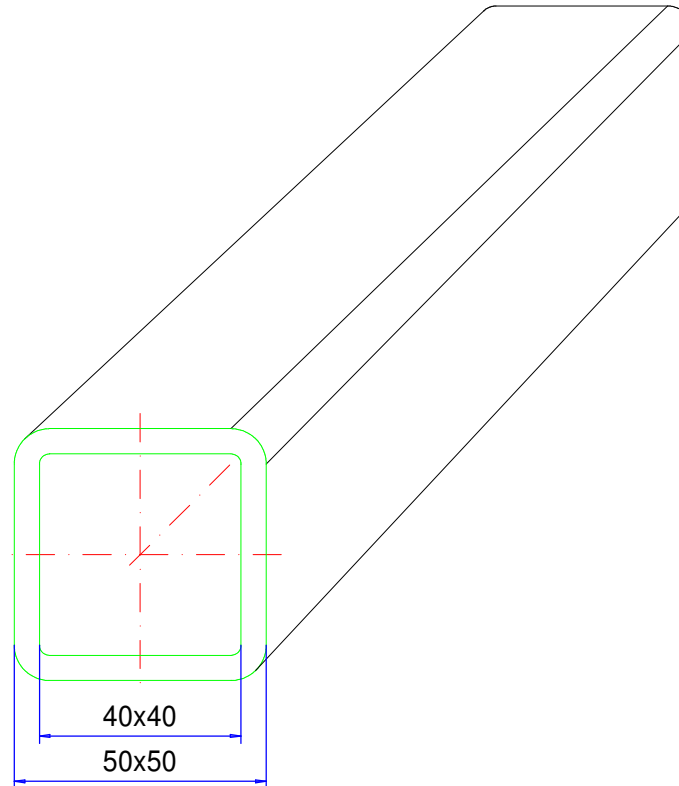

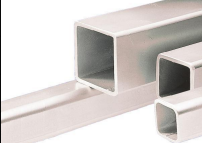
Material system elements	Welded precision steel		Pivoting range	---
Gasket	---		Weight	5,500 kg
Assembly screws	---		Coating	Powder coating RAL 7035, light grey
Ingress protection	IP54 EN 60529		Tolerance	EN 10305-4 (DIN 2391)