



Our *passion* is enclosures.



Enclosure world.

The ROLEC general catalog.

Welcome to the inventor of the industrial enclosure

A family business with a long tradition and aware of its responsibility – learn more about us.



Our passion is enclosures.

	A External mounting		P 60 Panel 60 mm deep
	B Block terminal support		P 90 Panel 90 mm deep
	BF Battery compartment		PR Profile handle system
	C Coloured design covers / caps		Q Cross rail
	D Silicone enclosure gasket		RS Rear wall with hinge
	DA Aluminium design covers		S Hinges
	DH Lid supports		SF DIN rail mounting kit
	DP POM design covers		SH Protective cover
	DV Double-bit fastener		ST Insert lock
	EMC Shielding		SV Quick-acting closure
	EP Electro-polishing		SZ Quick-acting closure with lock
	F Front plate self-adhesive		T Supporting rails for series terminals
	FE Window		TM Keyboard/mouse holder
	H Hand screw		V Slotted head screw/closure
	HG multiPANEL handle		VR Bolted rear wall
	HS Hold hinges		W Triangular screw/closure
	I Handle system		WA Wall connection
	ID Integrated lid supports		WM Elbow assembly set
	IN Captive Allen screw		X Collar-head screw/closure
	IS Internal hinges		Y Lever fastener
	J Handle		Z Lever fastener with lock
	L Corrosion proof coating		ZL Inch
	LH P.C.B. support for cards		
	M Mounting plates		
	MH Pole/Mast Support support		67 Ingress protection IP 67
	P Sealing set		69K Ingress protection IP 69K



The ROLEC principle: Technical perfection with top quality.

Our company founders, Friedhelm, Matthias and Betty Rose, are pioneers of enclosure technology. Sophisticated design and maximum customer benefits are our primary focus. It is for this reason that we ensure our products are of top quality.



We are a medium-sized family company, steering our global business from the German headquarters in Rinteln an der Weser. ROLEC offers you industrial enclosures produced from aluminium, stainless steel, ASA and ABS, as well as command enclosures and suspension arm systems. We offer a wide range of standard sizes, as well as customer-specific tailored solutions.

One of our particular strengths is machining components to be ready for installation. Using our high-tech production facilities, we modify the enclosures to be ready for installation according to our customers' wishes. We can deliver the finished products at short notice and "just in time" on request. You'll learn more on the following pages.

From the idea to the ready-to-install enclosure

A family business with a long tradition and aware of its responsibility – learn more about us.



Our passion is enclosures.



High-quality and first-class in every production phase.

Our special strength lies in the development of new enclosure concepts. Whether mass production that is suitable for series production or individual custom-made products – we at ROLEC are specialised in the special requirements and wishes of our customers.

We have always set standards with our creativity in developing new products. Numerous products and patents speak for themselves. Whether with the revolutionary single-channel technology, which creates a lot of interior space, our STANDARD EMC housing, which avoids additional costs for expensive EMC seals, or the idea of being able to attach enclosures in a closed state without having to open the sealed space during assembly – ROLEC has always been customer- and application-orientated.

ROLEC enclosures are produced on state-of-the-art die-cast aluminium and plastic-injection moulding machines. High-quality moulds guarantee top quality, so that the housings are largely free of a shrink holes and have a surface that meets the highest demands.

One of our particular strengths is machining components to be ready for installation. Using our high-tech production facilities, we modify the enclosures to be ready for installation according to our customers' wishes and supply them in any colour desired. We can deliver the finished products at short notice and "just in time" on request. We keep all items in our product line in inventory for fast availability. ROLEC can generally provide a sample in one to two workdays. That's standard service at ROLEC.



More information online

Learn all about ROLEC, services and products at the click of a mouse.



Our passion is enclosures.

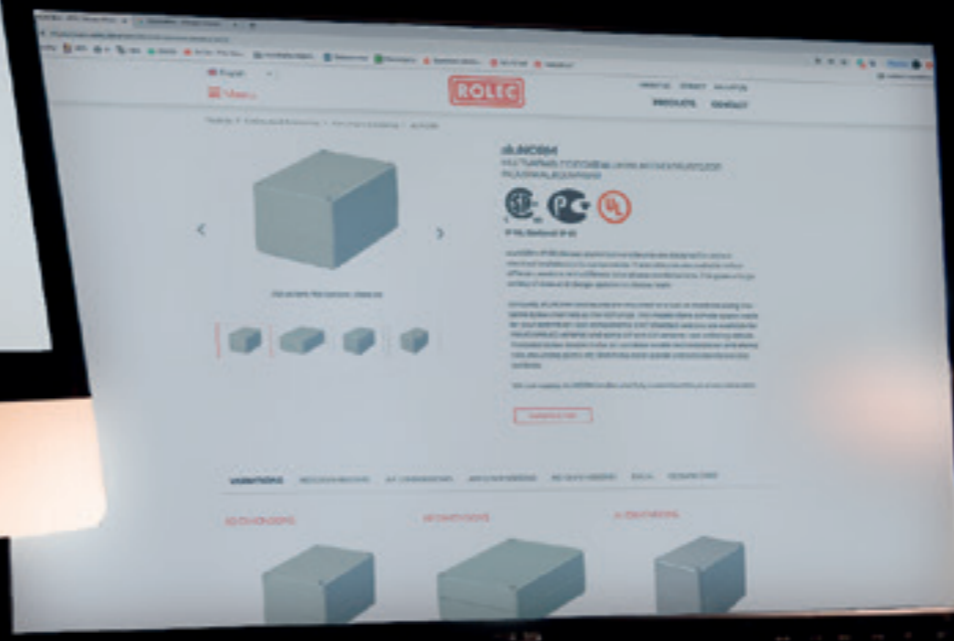

3D downloads & more can be found for free on our website

Online, you can quickly find the ideal product for you according to various selection criteria. Whether by ingress protection, approval, dimensions or material – no matter what is important for you: the various search criteria provide you with support when selecting your products.

Once you have found the right product, you will find the corresponding documentation, 2D and 3D data for each product for download free of charge.

You are welcome to send us an enquiry via the function 'Put product on a watch list', to which you are happy to attach your manufacturing drawings.

And if you have any questions about the products, our staff will be happy to assist you as competent points of contact. You will find them on our website under the menu item 'Contact'.

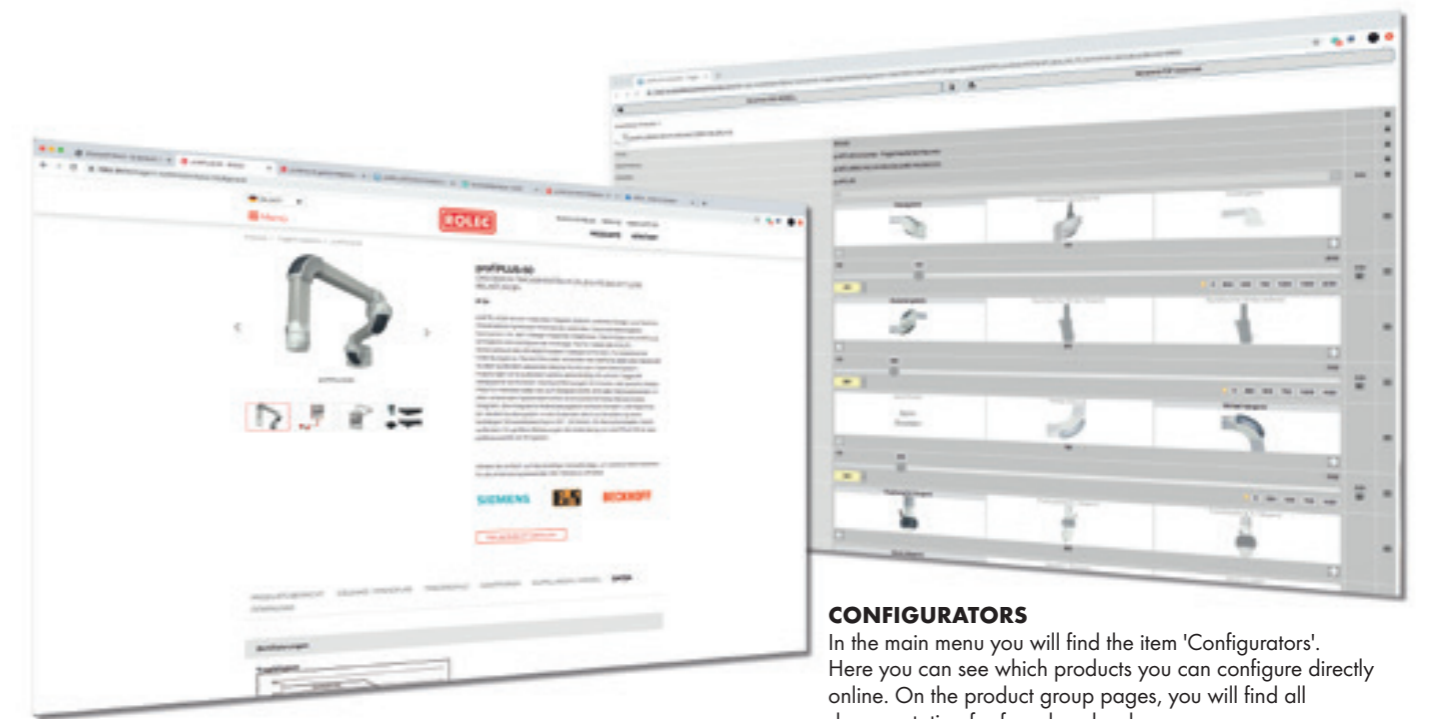

CONFIGURATORS
In the main menu you will find the item 'Configurators'. Here you can see which products you can configure directly online. On the product group pages, you will find all documentation for free download.

At home around the world

Quality Made in Germany – wherever you are in the world.



Our passion is enclosures.

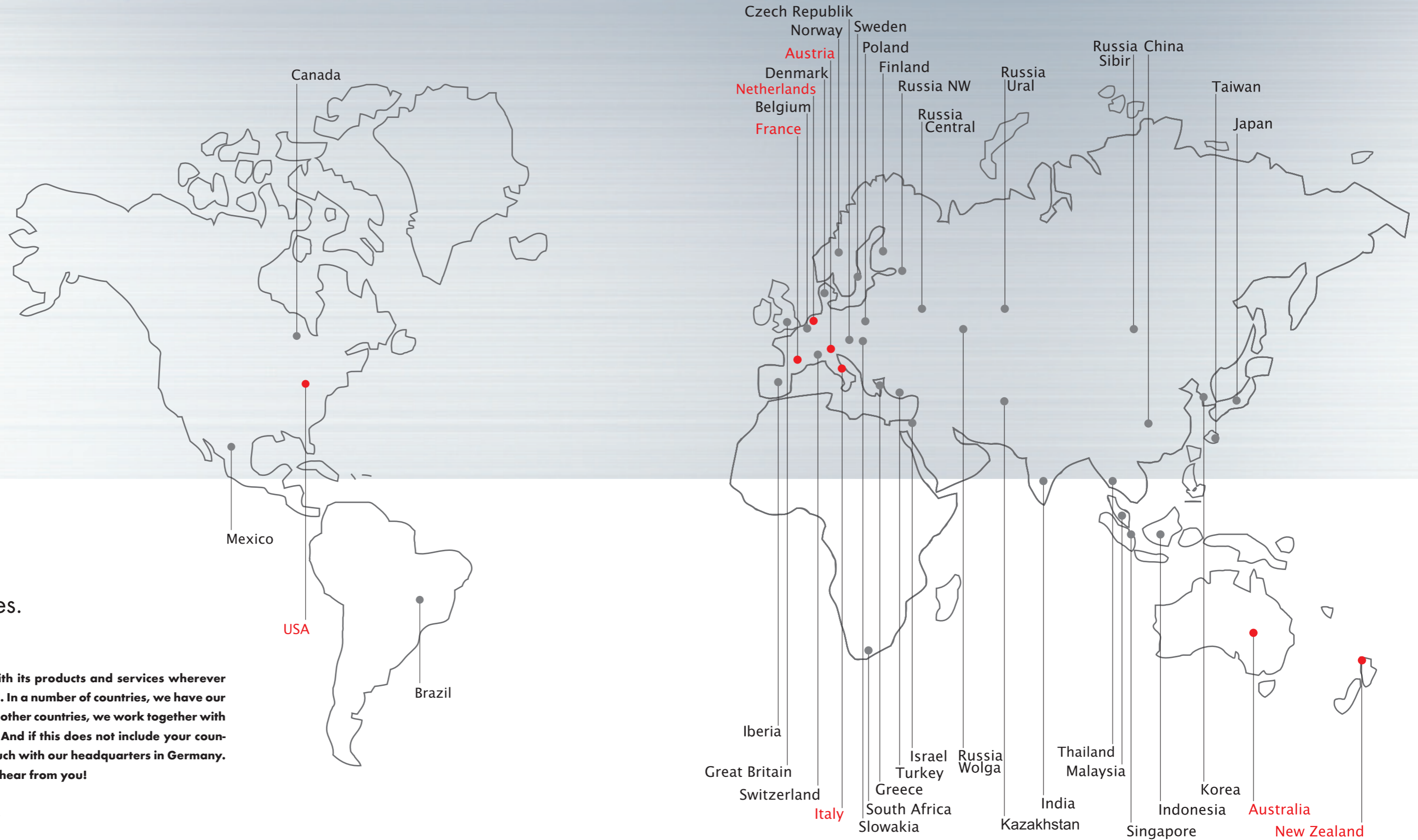

Global sales.

ROLEC is present with its products and services wherever you are in the world. In a number of countries, we have our own subsidiaries. In other countries, we work together with long-term partners. And if this does not include your country, simply get in touch with our headquarters in Germany. We'll be pleased to hear from you!

- = ROLEC subsidiaries
- = Distribution partner





Explanation of ingress protection



Per EN 60529 / DIN 40050







Our passion is enclosures.





DEFINITION OF THE 1st IP CODE

IP 1st CODE	INGRESS PROTECTION AGAINST CONTACT AND FOREIGN BODIES
PROTECTION AGAINST	SCOPE OF PROTECTION
0 Not protected. 	-----
1 Large foreign bodies. 	Protection against accidental large surface contact with live and internal moving parts, e.g. by the hand, although no protection against intentional access to these parts. Protection against the penetration of solid foreign bodies with a diameter greater than 50 mm.
2 Medium-sized foreign bodies. 	Protection against contact between the fingers and live or internal moving parts. Protection against the penetration of solid foreign bodies with a diameter greater than 12 mm.
3 Small foreign bodies. 	Protection against contact between live or internal moving parts and tools, wire, etc. with a thickness of more than 2.5 mm. Protection against the penetration of solid foreign bodies with a diameter greater than 2.5 mm.

IP 1st CODE	INGRESS PROTECTION AGAINST CONTACT AND FOREIGN BODIES
PROTECTION AGAINST	SCOPE OF PROTECTION
4 Granular foreign bodies. 	Protection against contact with live or internal moving parts with tools, wires etc. with a thickness of more than 1 mm.
5 Dust deposits. 	Complete protection against contact with live parts or parts moving internally. Protection against harmful dust deposits. The ingress of dust is not fully prevented but dust shall not penetrate in such quantities as to affect the functionality.
6 Dust ingress. 	Complete protection against contact with live parts or parts moving internally. Protection against the ingress of dust.

DEFINITION OF THE 2nd IP CODE

IP 2nd CODE	INGRESS PROTECTION AGAINST WATER PROTECTION
PROTECTION AGAINST	SCOPE OF PROTECTION
0 Not protected. 	-----
1 Protected against water droplets. 	Vertically falling droplets must not have any damaging effects.
2 Protected against water droplets if the enclosure is inclined up to 15°. 	Vertically falling droplets must not have any damaging effects if the enclosure is inclined up to an angle of 15° either side of vertical.
3 Protected against water spray. 	Water that is sprayed at an angle of up to 60° either side of vertical must not have any damaging effects.
4 Protected against splash water. 	Water that is splashed against the enclosure from any direction must not have any damaging effects.

IP 2nd CODE	INGRESS PROTECTION AGAINST WATER PROTECTION
PROTECTION AGAINST	SCOPE OF PROTECTION
5 Protected against water jets. 	Water that is sprayed in a jet against the enclosure from any direction must not have any damaging effects.
6 Protected against powerful water jets. 	Water that is sprayed from any direction as a powerful jet against the enclosure must not have any damaging effects.
7 Protection against the effects of temporary submersion in water. 	Water must not seep into the enclosure in any quantity that may have damaging effects when the enclosure is temporarily submersed under water under standard pressure and time conditions.
8 Protection against the effects of long-term submersion in water. 	Water must not seep into the enclosure in any quantity that may have damaging effects when the enclosure is submersed under water on a long-term basis under conditions that are agreed between the manufacturer and user. These conditions must however be harsher than those for code 7.
9K Water during high pressure/steam spray cleaning 	Water that is sprayed in a powerful, increased pressure jet against the enclosure from any direction must not have any damaging effects.

Cited abbreviations.

The Ingress Protection is specified as abbreviations. These always comprise the identical identification letters IP and TWO CODE NUMBERS for the degree of protection.

Furthermore, on request ROLEC standard enclosures made of aluminium and polyester can be produced in Ingress Protection IP 67 and IP 69K.

As standard, virtually all ROLEC enclosures are designed according to the ingress protection IP 65 and IP 66 and therefore meet the high industrial standard for serial products, i.e. the enclosure offers protection against the ingress of water and dust.

Personal service for everyone

We support and advise all our customers individually. Regardless of whether for an individual item or series production.



Our passion is enclosures.



Expert advice

Everything begins with individual advice. We'll be pleased to support you with your project and find solutions for every requirement. Customer-specific solutions are our speciality.



Sample service

Test our products with your internal mounting. We'd be pleased to send you a sample enclosure for inspection with no strings attached.



Drilling

From fine fits right to large drill holes – we'll manufacture every enclosure according to your individual specifications.



Milling

Thanks to our modern CNC production, we can quickly and efficiently mill custom-fit cut-outs and contours, to match your exact specifications.



Engraving

Our services also include engraving your logo and other elements, which we can of course perform in any colour you desire.



Lasering

We can process stainless steel enclosures and plates quickly and reliably according to your individual requirements thanks to our in-house lasering centre.



Assembly

Would you like to have all your components supplied already assembled? No problem. Our assembly team will be pleased to perform all assembly work on your behalf.



Powder coating

We can powder coat enclosures, command enclosures and suspension systems in any RAL colour you wish. Custom colours are of course also possible.

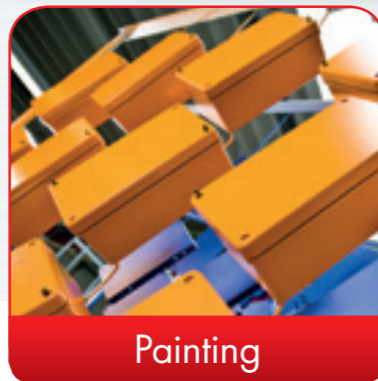

Painting

We can also paint all our enclosures in any RAL colour you desire. The application of primer and special colour structures are possible, as well.



Serigraphy

If desired, we can apply your logo and lettering or other markings using serigraph printing.



Digital printing

Digital printing is particularly worthwhile for low-volume orders and for realising complex. Realising complex patterns or images.



Accessories

ROLEC's portfolio also includes matching front plates, mounting plates, supporting rails and terminal blocks as well as a range of cable glands, blanking plugs etc.



Membrane keypads

We'll be glad to design customised membrane keypads and attach them in accordance with your requirements.



Digital print films

Custom accessories that we can produce and assemble for you also include display foils.



EMC enclosures

We offer our conFORM low-price standard EMC enclosure to protect your internal mountings against electromagnetic radiation. On request, we can also supply an EMC-compliant version of any other ROLEC enclosure.



Displays

We are able to offer the right made-to-measure display for all our enclosures – in varying sizes and degrees of robustness depending on the application.

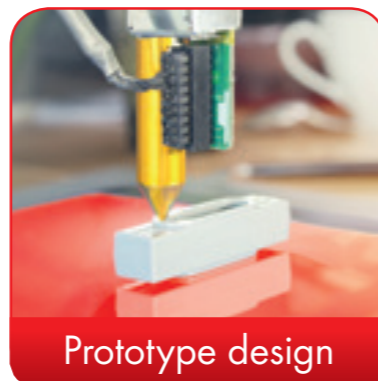

Prototype design

We will visualise your ideas in the planning and development stage, making them tangible. As initial samples for tests or the basis for developing applications.



Special material

If you need a plastic enclosure in a special material, such as polycarbonate or ASA – no problem. We'll be pleased to produce limited series for you, too.

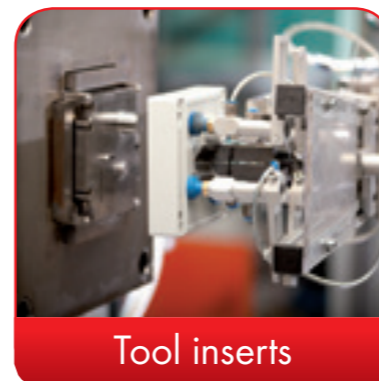

Tool inserts

Our standard tools can accommodate interchangeable inserts in the most frequently used interfaces – allowing modifications to be made. This means that special requests can be realised quickly, reliably and affordably.



Special tools

Our specialists will be pleased to discuss your customised enclosure design for enclosures and enclosure parts produced in large volumes. We can also realise the most unusual project designs quickly and according to your requirements.

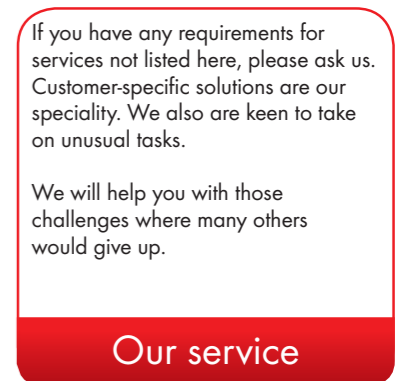

Our service

If you have any requirements for services not listed here, please ask us. Customer-specific solutions are our speciality. We also are keen to take on unusual tasks.

We will help you with those challenges where many others would give up.

The ROLEC product portfolio

Enclosures, mobile control enclosures, command enclosures, suspension systems



Our passion is enclosures.

■ Aluminium enclosures ■ Stainless steel enclosures ■ Mobile control enclosures ■ Plastic enclosures ■ Polyester enclosures ■ Command enclosures ■ Suspension systems ■ Cable glands

<p>aluDISC 18-19</p>  <ul style="list-style-type: none"> - Fastening of the enclosure without opening the lid - Dimensions from 110x97x55 mm to 190x179x90 mm - IP 66, IP 67/EN 60529 	<p>aluCASE 20-21</p>  <ul style="list-style-type: none"> - Fastening of the enclosure without opening the lid - Dimensions from 75x50x33 mm to 330x200x120 mm - IP 66, IP 67/EN 60529 	<p>aluCLIC 22-23</p>  <ul style="list-style-type: none"> - World-first quick-change enclosure - Dimensions from 130x90x70 mm to 200x130x70 mm - IP 66, IP 67/EN 60529 	<p>aluPLUS 24-25</p>  <ul style="list-style-type: none"> - Designer enclosure with technical finesse - Dimensions from 125x84x59 mm to 260x160x90 mm - IP 66/EN 60529 	<p>aluKOM 26-27</p>  <ul style="list-style-type: none"> - The ORIGINAL enclosure from the inventor Friedhelm Rose - Dimensions from 50x45x30 mm to 600x310x110 mm - IP 66/EN 60529
<p>aluNORM 28-33</p>  <ul style="list-style-type: none"> - Versatile combination universal enclosure - Dimensions from 50x65x40 mm to 640x320x120 mm - IP 66/EN 60529 	<p>conFORM 34-35</p>  <ul style="list-style-type: none"> - Inexpensive and robust EMC enclosure - Dimensions from 79x84x44 mm to 268x168x100 mm - IP 66/EN 60529 	<p>aluTWIN 36-37</p>  <ul style="list-style-type: none"> - Two-chamber enclosure with separate connection spaces - Dimensions from 166x100x55 mm to 240x240x103 mm - IP 66/EN 60529 	<p>inoCASE A4 40-41</p>  <ul style="list-style-type: none"> - Fastening without holes in the enclosure interior - Dimensions from 140x110x60 mm to 430x300x120 mm - IP 66, IP 67/EN 60529 	<p>inoBOX A2 / A4 42-43</p>  <ul style="list-style-type: none"> - High quality stainless steel range from A2 and A4 - Dimensions from 100x100x90 mm to 400x300x120 mm - IP 66/EN 60529
<p>handCASE 46-47</p>  <ul style="list-style-type: none"> - Highly robust hand-held enclosures - 4 versions, dimensions from 80x180x42.4 mm to 100x220x62.4 mm - IP 66, IP 67/EN 60529 	<p>mobilCASE 48-49</p>  <ul style="list-style-type: none"> - Profile enclosures - 3 standard widths in 2 versions respectively - 1-part profile IP 65 - 2-part profile IP 54/EN 60529 	<p>aluDISPLAY 50-51</p>  <ul style="list-style-type: none"> - Variable display and operating enclosures for flat modules - 3 profile sizes, 180, 240 and 300 mm - IP 54/EN 60529 	<p>starCASE 54-55</p>  <ul style="list-style-type: none"> - Elegant designer enclosure made of ASA+PC - Dimensions from 120x90x50 mm to 280x170x60 mm - IP 66/EN 60529 	<p>technoDISC 56-57</p>  <ul style="list-style-type: none"> - Round designer enclosure made of ASA+PC - Dimensions from 110x97x55 mm to 190x179x90 mm - IP 66/EN 60529
<p>technoPLUS 58-59</p>  <ul style="list-style-type: none"> - UV-stable premium enclosure from ASA - Dimensions from 130x90x70 mm to 270x170x90 mm - IP 66, IP 67/EN 60529 	<p>technoCASE 60-61</p>  <ul style="list-style-type: none"> - Multi-variable enclosure produced from ABS and polycarbonate - Dimensions from 80x80x60 mm to 360x240x160 mm - IP 66, IP 67/EN 60529 	<p>technoBOX 62-63</p>  <ul style="list-style-type: none"> - Elegant standard enclosure produced from ABS - Dimensions from 66x51x35 mm to 241x1610x80 mm - IP 66/EN 60529 	<p>polyTOP 66-67</p>  <ul style="list-style-type: none"> - Modular enclosure from weather-resistant polyester - Dimensions from 82x82x60 mm to 404x404x160 mm - IP 66/EN 60529 	<p>polyDOOR 68-69</p>  <ul style="list-style-type: none"> - Stable polyester enclosure with folding lid - Dimensions from 140x120x100 mm to 320x200x120 mm - IP 66/EN 60529
<p>polyKOM 70-71</p>  <ul style="list-style-type: none"> - Robust, weather-resistant polyester enclosure - Dimensions from 80x75x55 mm to 400x405x120 mm - IP 65/EN 60529 	<p>multiPANEL 74-77</p>  <ul style="list-style-type: none"> - Premium command enclosure made of aluminium profiles - Dimensions from 150x150x70 mm to 800x800x130 mm - Up to IP 65 / EN 60529 	<p>profiPANEL 78-81</p>  <ul style="list-style-type: none"> - Designer command enclosure made of aluminium profiles - Dimensions from 150x150x60 mm to 800x800x300 mm - Up to IP 65 / EN 60529 	<p>commandCASE 82-83</p>  <ul style="list-style-type: none"> - Economical command enclosure with design handles - Dimensions from 230x200x120 mm to 430x300x120 mm - IP 66/EN 60529 	<p>aluFACE 84-87</p>  <ul style="list-style-type: none"> - Economical with diverse variation options - 6 variants, dimensions from 120x120x80 mm to 640x320x135 mm - IP 66/EN 60529
<p>multiVISION 88-91</p>  <ul style="list-style-type: none"> - 2 versions, numerous variation options - To the precise millimetre per customer wishes to 800x800x360 mm - IP 65/EN 60529 	<p>profiPLUS 50 & 70 94-101</p>  <ul style="list-style-type: none"> - Designer suspension system with numerous components - Equipotential bonding - Simple installation and adjustment/alignment - IP 54/EN 60529 	<p>taraPLUS 102-105</p>  <ul style="list-style-type: none"> - Enhanced static characteristics - Simple alignment of the system - Simple cable installation - IP 54/EN 60529 	<p>QUADRO 106-107</p>  <ul style="list-style-type: none"> - Stable system for the greatest loads - Highly durable - Aluminium/spheroidal graphite iron combination - IP 54/EN 60529 	<p>Cable glands & more</p>  <ul style="list-style-type: none"> - Range of materials, appropriate for the enclosures - IP 54, IP 55, IP 65, IP 66, IP 68, IP 69K - Further accessories such as blanking plugs, front plates, etc.

You can find detailed information on all our products and our company on our website, www.rolec.de/en

Aluminium enclosures

Perfect design and technology



Ingress protection IP 66/IP 67, optional IP 69K



aluDISC

An absolute all-rounder in every respect

The first round aluminium enclosure for industrial electronics and electronic components. The cover comes with a recess to accommodate a membrane keypad or a front plate. Enclosure can be fastened when the cover is fitted.



The key product features:

- Enclosure material: Die-cast aluminium
- Enclosure surface: powder coating, RAL 7035
- Lid screws in stainless steel 1.4567
- Ingress protection IP 66/IP 67
- Enclosure seal: Silicone moulded gasket

Ordering overview aluDISC

Type	Art. no.	L	W	H	D	E	F	G	g	M	EMC	SH	T	ID	69K
AR 080	280.080.000	110	97	55	89.8	45.2	27.5	12.5	410	o	o		o		o
AR 100	280.100.000	130	119	65	99.4	68.4	40.5	27.5	590	o	o		o	o	o
AR 120	280.120.000	150	139	80	116.5	80	55.5	40	820	o	o	o	o	o	o
AR 160	280.160.000	190	179	90	155.5	99	65.5	57.5	1190	o	o		o	o	o



• Standard o Optionally available



Standard: Clip-on Design covers.



Standard: The enclosure can be fastened when the cover is fitted.



Standard: Integrated recess to accommodate membrane keypad or front plate.



Integrated lid support.

Approvals:

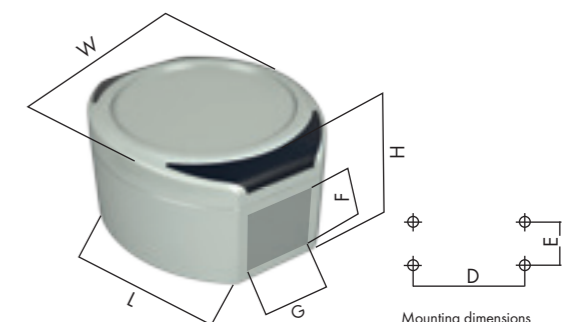

Mounting dimensions

Ingress protection IP 66/IP 67, optional IP 69K



aluCASE

The premium aluminium enclosure

Ergonomically designed aluminium enclosure for industrial electronics. Whether in the line of sight on a wall or for mechanical engineering. The enclosure can be mounted even when the lid is fitted.



The key product features:

- Enclosure material: Die-cast aluminium
- Enclosure surface: powder coating, RAL 7040
- Enclosure can be mounted even when the lid is fitted
- Integrated recess in lid for membrane keypad or front plate
- Clip-on design covers
- Lid screws in stainless steel 1.4567
- Ingress protection IP 66/IP 67
- Enclosure seal: TPE moulded gasket, silicone-free
O-ring gasket (CR)

Ordering overview aluCASE

Type	Art. no.	L	W	H	D	E	g	ID	DP	DA	S	ST	L	D	EMC	69K
AC 052	191.052.000	75	50	33	61	34	134		•				o	o	o	o
AC 054	191.054.000	100	50	33	86	34	166		•				o	o	o	o
AC 070	191.070.000	100	70	50	84	33	328		•				o	o	o	o
AC 072	191.072.000	140	70	50	124	33	411		•				o	o	o	o
AC 074	191.074.000	180	70	50	164	33	495		•				o	o	o	o
AC 090	191.090.000	120	90	60	102	40	580	•	•	o			o	o	o	o
AC 092	191.092.000	160	90	60	142	40	680	•	•	o			o	o	o	o
AC 092K	192.092.000	160	90	60	142	40	520	•	•	o			o	o	o	o
AC 094	191.094.000	250	90	60	232	40	861	•	•	o			o	o	o	o
ACF 110	190.110.000	140	110	60	122	60	700	•	•	o	o	o	o	o	o	o
ACF 110K	192.110.000	140	110	60	122	60	534	•	•	o			o	o		o
ACF 112	190.112.000	200	110	60	182	60	880	•	•	o	o	o	o	o	o	o
ACF 130	190.130.000	160	130	70	142	80	910	•	•	o	o	o	o	o	o	o
ACF 132	190.132.000	220	130	70	202	80	1130	•	•	o	o	o	o	o	o	o
ACF 150	190.150.000	180	150	60	162	100	968	•	•	o	o	o	o	o	o	o
AC 150	191.150.000	180	150	90	162	100	1216	•	•	o	o	o	o	o	o	o
ACF 152	190.152.000	260	150	60	242	100	1273	•	•	o	o	o	o	o	o	o
AC 152	191.152.000	260	150	90	242	100	1569	•	•	o	o	o	o	o	o	o
ACF 170	190.170.000	200	170	60	182	120	1096	•	•	o	o	o	o	o	o	o
AC 170	191.170.000	200	170	90	182	120	1430	•	•	o	o	o	o	o	o	o
ACF 172	190.172.000	280	170	60	262	120	1471	•	•	o	o	o	o	o	o	o
AC 172	191.172.000	280	170	90	262	120	1789	•	•	o	o	o	o	o	o	o
ACF 200	190.200.100	230	200	90	212	144	1720	•	•	o	o	o	o	o	o	o
AC 200	191.200.100	230	200	120	212	144	2005	•	•	o	o	o	o	o	o	o
AC 202	191.202.100	330	200	120	312	144	2328	•	•	o	o	o	o	o	o	o
* AC 250	191.250.100	280	250	120	262	194	2643	•	•	o	o	o	o	o	o	o
* AC 252	191.252.100	380	250	120	362	194	3295	•	•	o	o	o	o	o	o	o
* AC 300	191.300.100	330	300	120	312	244	3353	•	•	o	o	o	o	o	o	o
* AC 302	191.302.100	430	300	120	412	244	4092	•	•	o	o	o	o	o	o	o

* IP 66: O-ring gasket (CR)

• Standard o Optionally available



Standard: Integrated lid support.

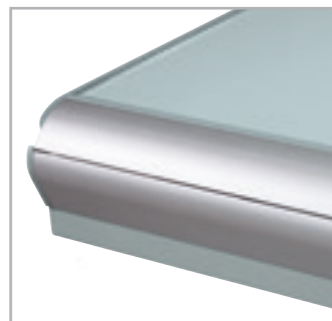

External hinges without visible screws.



Transparent lid for the sizes AC 092K and ACF 110K.



Access protection by means of insert lock.

Approvals:

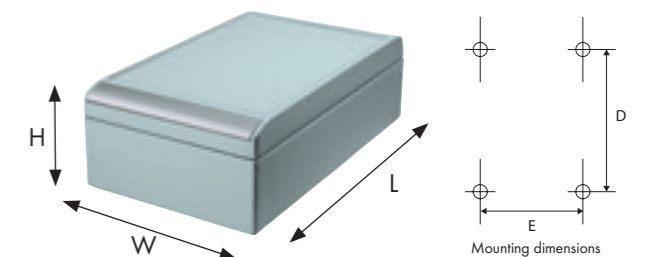

Ingress protection IP 66, IP 67, optional IP 69K



aluCLIC

The quick-change enclosure

State-of-the-art electronic enclosure, designed for fast installation and quick exchange. The screw mounting at the rear allows virtually all the enclosure front to be used.



The key product features:

- Enclosure material: Die-cast aluminium
- Enclosure surface: powder coating, RAL 7035
- Enclosure can be mounted even when the lid is fitted
- Integrated recess in cover for membrane keypad or front plate
- Snap-on fastening to quick-change support
- Enclosure front almost fully usable
- Lid screws in stainless steel 1.4567
- Ingress protection: IP 66, IP 67
- Enclosure seal: TPE moulded gasket, silicone-free

Ordering overview aluCLIC

Type	Art. no.	L	W	H	D	E	g	M	L	EMC	69K
ACL 092	240.092.000	130	90	70	96	46	610	o	o	o	o
ACL 112	240.112.000	160	110	70	116	66	810	o	o	o	o
ACL 132	240.132.000	200	130	70	156	86	1070	o	o	o	o

• Standard o Optionally available



Standard: Snap-on instead of screw-on.

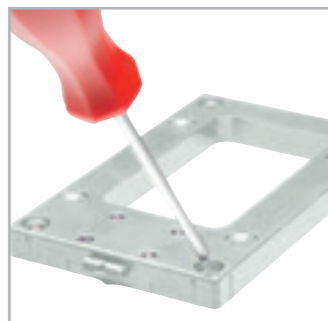

Standard: Snap-on support.



Standard: More space for internal components.



Standard: Lid fixed from the rear.

Approvals:

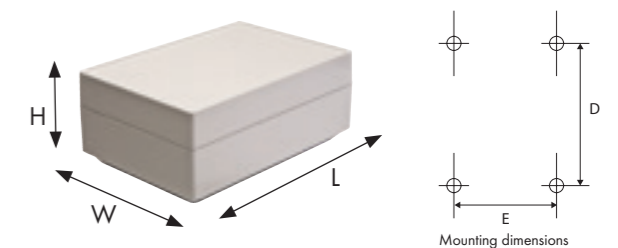

Mounting dimensions

Ingress protection IP 66, optional IP 67

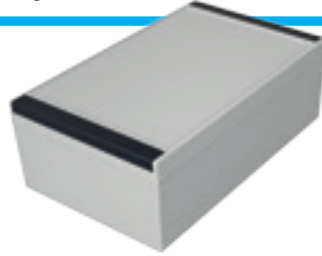

aluPLUS

The plus side of technology and design

Numerous areas of application. Suitable for wall attachment outdoors as well as industrial electronics and mechanical engineering. Snap-on design covers conceal the lid fixings and mounting screws, giving the enclosure an attractive appearance.



The key product features:

- Enclosure material: Die-cast aluminium
- Enclosure surface: powder coating, RAL 7035
- Compatible with standard enclosures available on the market, therefore easy to exchange
- Lid screws in stainless steel 1.4567
- Ingress protection IP 66
- Enclosure seal: Silicone moulded gasket

Ordering overview aluPLUS

Type	Art. no.	L	W	H	D	E	g	M	D	DH	L	T	EMC	67
AP 082	196.082.000	125	84	59	113	52	395	o	•		o	o	o	o
AP 083	196.083.000	175	84	59	163	52	511	o	•		o	o	o	o
AP 100	196.100.000	100	100	82	87	65	575	o	•		o	o	o	o
AP 102	196.102.000	160	100	82	147	65	767	o	•		o	o	o	o
AP 120	196.120.000	122	120	82	106	82	770	o	•	o	o	o	o	o
AP 122	196.122.000	220	120	82	204	82	1110	o	•	o	o	o	o	o
AP 161	196.161.000	160	160	90	140	110	1190	o	•	o	o	o	o	o
AP 162	196.162.000	260	160	90	240	110	1620	o	•	o	o	o	o	o



• Standard o Optionally available



Standard: Clip-on design covers. PBT, RAL 7016



Standard: The enclosure can be mounted even when the lid is fitted.



Standard: Integrated recess to accommodate a membrane keypad or front plate.



Integrated lid support.

Approvals:

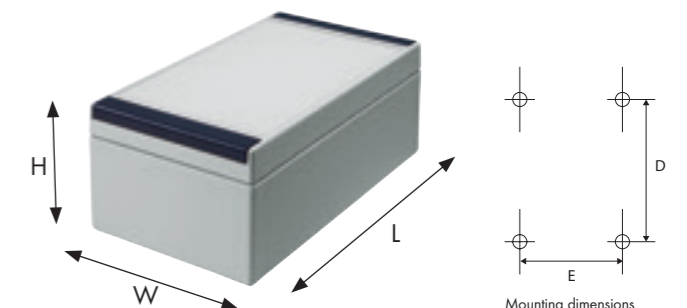

Mounting dimensions

Ingress protection IP 66



aluKOM

The classic standard enclosure

The original enclosure that became a global standard. Originally developed as a terminal enclosure, it is ideal for attaching all types of electronic and electrical components.

The key product features:

- Enclosure material: Die-cast aluminium
- Enclosure surface: powder coating, RAL 7032
- Compatible with standard enclosures available on the market, therefore easy to exchange
- Lid screws in stainless steel 1.4567
- Ingress protection IP 66
- Enclosure seal: TPE moulded gasket, silicone-free O-ring gasket (CR)



Ordering overview aluKOM

Type	Art. no.	L	W	H	D	E	g	M	D	A	L	T	HS	IS	S	DH	EMC
* AK 060	106.060.000	50	45	30	40	35	80		o		o	o					o
AK 061	106.061.000	58	64	36	46	36	160		o		o	o					o
AK 062	106.062.000	98	64	36	86	36	220		o		o	o					o
AK 063	106.063.000	150	64	36	138	36	340		o		o	o					o
AK 081	106.081.000	75	80	57	63	52	290	o	o	o	o	o					o
AK 082	106.082.000	125	80	57	113	52	440	o	o	o	o	o					o
AK 083	106.083.000	175	80	57	163	52	530	o	o	o	o	o					o
AK 084	106.084.000	250	80	57	238	52	720	o	o	o	o	o					o
AK 120	106.120.000	122	120	81	106	82	950	o	o	o	o	o	o	o	o	o	o
AK 121	106.121.000	122	120	91	106	82	970	o	o	o	o	o	o	o	o	o	o
AK 122	106.122.000	220	120	81	204	82	1420	o	o	o	o	o	o	o	o	o	o
AK 123	106.123.000	220	120	91	204	82	1450	o	o	o	o	o	o	o	o	o	o
* AK 124	106.124.000	360	120	81	344	82	1860	o	o	o	o	o	o	o	o	o	o
AK 161	106.161.000	160	160	90	140	110	1410	o	o	o	o	o	o	o	o	o	o
AK 162	106.162.000	260	160	90	240	110	1950	o	o	o	o	o	o	o	o	o	o
* AK 163	106.163.000	360	160	90	340	110	2540	o	o	o	o	o	o	o	o	o	o
* AK 164	106.164.000	560	160	90	540	110	4310	o	o	o	o	o	o	o	o	o	o
* AK 231	106.231.000	200	230	110	180	180	2720	o	o	o	o	o	o	o	o	o	o
* AK 232	106.232.000	280	230	110	260	180	3850	o	o	o	o	o	o	o	o	o	o
* AK 233	106.233.000	330	230	110	310	180	4270	o	o	o	o	o	o	o	o	o	o
* AK 234	106.234.000	400	230	110	380	180	4880	o	o	o	o	o	o	o	o	o	o
* AK 235	106.235.000	600	230	110	580	180	6380	o	o	o	o	o	o	o	o	o	o
* AK 311	106.311.000	402.5	310	110	382	261	6300	o	o	o	o	o	o	o	o	o	o
* AK 312	106.312.000	600	310	110	580	261	8480	o	o	o	o	o	o	o	o	o	o

* O-ring gasket (CR)

• Standard o Optionally available



External mounting.



Lid support.



Hold hinge.



Exterior hinge.

Approvals:

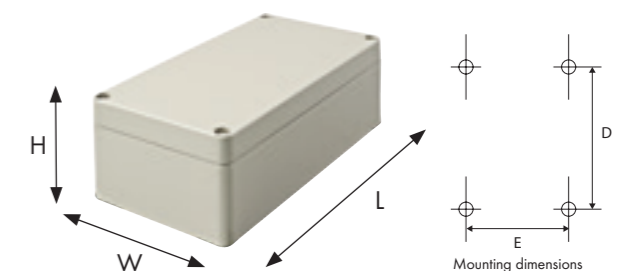

Mounting dimensions

Ingress protection IP 66, optional IP 67



aluNORM

The multivariable aluminium enclosure

Four versions available in a huge number of standard sizes. Can be combined, from extremely flat to extremely high. Single-channel mounting provides even more space to install electronic components inside.

The key product features:

- Enclosure material: Die-cast aluminium
- Enclosure surface: powder coating, RAL 7035
- Single-channel mounting for greater installation volume
- Sizes compatible with polyTOP polyester enclosures, therefore easy to exchange
- Lid screws in stainless steel 1.4567
- Ingress protection IP 66
- Enclosure seal: TPE moulded gasket, silicone-free
O-ring gasket (CR)
Profile seal (CR)

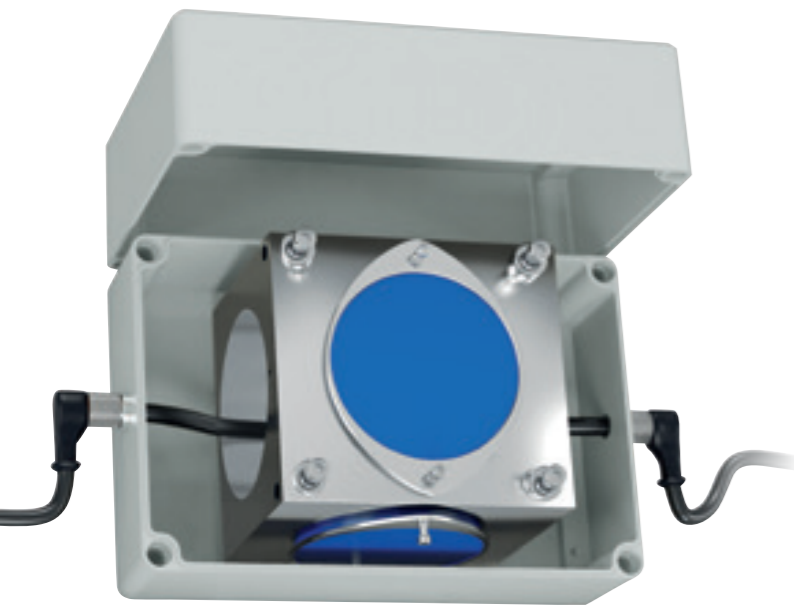

aluNORM version AF
Flat lid, flat bottom



aluNORM version AS
Flat lid, high bottom



aluNORM version AD
High lid, flat bottom



aluNORM version AH
High lid, high bottom



External mounting.



Exterior hinge.



Hold hinge.



Internal (sprung) hinge.

Approvals:



Ordering overview aluNORM AF



Type	Art. no.	L	W	H	D	E	g	M	D	A	Q	B	L	T	S	HS	EMC	67
AF 080	102.080.035	80	80	40	67	67	240	o	o	o	o	o	o				o	o
AF 082	102.082.035	120	80	40	107	67	330	o	o	o	o	o	o				o	o
* AF 084	102.084.035	160	80	40	147	67	400	o	o	o	o	o	o				o	o
AF 100	102.100.035	100	100	54	87	87	420	o	o	o	o	o	o				o	o
AF 102	102.102.035	150	100	54	137	87	540	o	o	o	o	o	o				o	o
* AF 104	102.104.035	200	100	54	187	87	690	o	o	o	o	o	o				o	o
* AF 120	102.120.035	120	120	66	102	102	780	o	o	o	o	o	o	o	o	o	o	o
AF 122	102.122.035	180	120	66	162	102	1010	o	o	o	o	o	o	o	o	o	o	o
AF 124	102.124.035	240	120	66	222	102	1260	o	o	o	o	o	o	o	o	o	o	o
* AF 160	102.160.035	160	160	66	142	142	1130	o	o	o	o	o	o	o	o	o	o	o
AF 162	102.162.035	240	160	66	222	142	1560	o	o	o	o	o	o	o	o	o	o	o
* AF 164	102.164.035	320	160	66	302	142	1910	o	o	o	o	o	o	o	o	o	o	o
* AF 166	102.166.035	480	160	66	462	142	3030	o	o	o	o	o	o	o	o	o	o	o
* AF 200	102.200.035	200	200	80	180	180	1780	o	o	o	o	o	o	o	o	o	o	o
* AF 202	102.202.035	300	200	80	280	180	2380	o	o	o	o	o	o	o	o	o	o	o
* AF 204	102.204.035	400	200	80	380	180	3560	o	o	o	o	o	o	o	o	o	o	o
* AF 240	102.240.035	240	240	80	220	220	2380	o	o	o	o	o	o	o	o	o	o	o
* AF 242	102.242.035	360	240	80	340	220	3630	o	o	o	o	o	o	o	o	o	o	o
* AF 244	102.244.035	480	240	80	460	220	4690	o	o	o	o	o	o	o	o	o	o	o
* AF 320	102.320.035	320	320	80	300	300	4000	o	o	o	o	o	o	o	o	o	o	o
* AF 322	102.322.035	480	320	80	460	300	5650	o	o	o	o	o	o	o	o	o	o	o
* AF 324	102.324.035	640	320	80	620	300	7350	o	o	o	o	o	o	o	o	o	o	o

* Profile seal (CR) • Standard o Optionally available

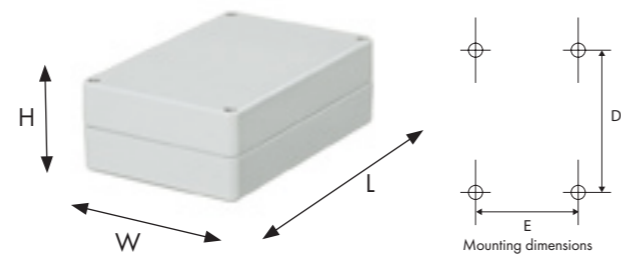

Ordering overview aluNORM AS



Type	Art. no.	L	W	H	D	E	g	M	D	A	B	L	T	S	IS	HS	EMC	67
AS 060	100.060.035	50	65	40	38	53	130	o	o	o	o	o	o				o	o
AS 062	100.062.035	65	65	40	53	53	170	o	o	o	o	o	o				o	o
AS 064	100.064.035	100	65	40	88	53	220	o	o	o	o	o	o				o	o
AS 066	100.066.035	150	65	40	138	53	310	o	o	o	o	o	o				o	o
AS 080	100.080.035	80	80	60	67	67	320	o	o	o	o	o	o				o	o
AS 082	100.082.035	120	80	60	107	67	460	o	o	o	o	o	o				o	o
AS 084	100.084.035	160	80	60	147	67	610	o	o	o	o	o	o				o	o
AS 100	100.100.035	100	100	80	87	87	550	o	o	o	o	o	o	o	o	o	o	o
AS 102	100.102.035	150	100	80	137	87	730	o	o	o	o	o	o	o	o	o	o	o
AS 104	100.104.035	200	100	80	187	87	910	o	o	o	o	o	o	o	o	o	o	o
AS 120	100.120.035	120	120	100	102	102	1070	o	o	o	o	o	o	o	o	o	o	o
AS 122	100.122.035	180	120	100	162	102	1310	o	o	o	o	o	o	o	o	o	o	o
AS 124	100.124.035	240	120	100	222	102	1680	o	o	o	o	o	o	o	o	o	o	o
AS 160	100.160.035	160	160	100	142	142	1520	o	o	o	o	o	o	o	o	o	o	o
AS 162	100.162.035	240	160	100	222	142	1980	o	o	o	o	o	o	o	o	o	o	o
* AS 164	100.164.035	320	160	100	302	142	2480	o	o	o	o	o	o	o	o	o	o	o
* AS 166	100.166.035	480	160	100	462	142	3900	o	o	o	o	o	o	o	o	o	o	o
* AS 200	100.200.035	200	200	120	180	180	2480	o	o	o	o	o	o	o	o	o	o	o
* AS 202	100.202.035	300	200	120	280	180	3250	o	o	o	o	o	o	o	o	o	o	o
* AS 204	100.204.035	400	200	120	380	180	4700	o	o	o	o	o	o	o	o	o	o	o
* AS 240	100.240.035	240	240	120	220	220	3400	o	o	o	o	o	o	o	o	o	o	o
* AS 242	100.242.035	360	240	120	340	220	4000	o	o	o	o	o	o	o	o	o	o	o
* AS 244	100.244.035	480	240	120	460	220	6100	o	o	o	o	o	o	o	o	o	o	o
* AS 320	100.320.035	320	320	120	300	300	4900	o	o	o	o	o	o	o	o	o	o	o
* AS 322	100.322.035	480	320	120	460	300	6600	o	o	o	o	o	o	o	o	o	o	o
* AS 324	100.324.035	640	320	120	620	300	8700	o	o	o	o	o	o	o	o	o	o	o

* O-ring gasket (CR) • Standard o Optionally available

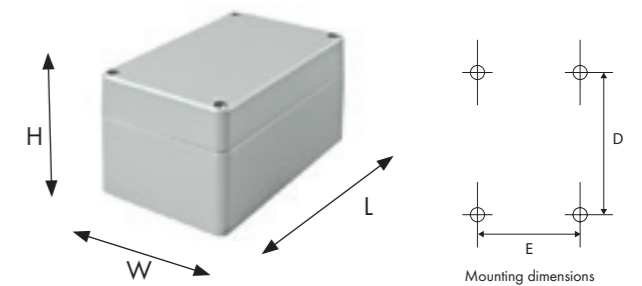

Ingress protection IP 66, optional IP 67



conFORM/conTROL

The Standard EMC enclosure

Extremely robust EMC enclosure comes with EMC shielding as standard without a costly conductive gasket. Perfect for electronic equipment that requires special EMC protection.

The key product features:

- Enclosure material: Die-cast aluminium
- Enclosure surface: powder coating, RAL 7032
- Sizes compatible with standard enclosures available on the market, therefore easy to exchange
- Lid screws in stainless steel 1.4567
- Ingress protection IP 66
- Enclosure seal: TPE moulded gasket



Ordering overview conFORM

Type	Art. no.	L	W	H	D	E	g	M	D	A	L	T	S	DH	EMC	67
EKF 081	111.081.000	79	84	44	63	52	260	o	o	o	o	o	o		•	o
EKF 082	111.082.000	130	85	44	113	52	408	o	o	o	o	o	o		•	o
EKF 083	111.083.000	180	85	44	163	52	538	o	o	o	o	o	o		•	o
EKF 121	111.121.000	127	125	60	106	82	880	o	o	o	o	o	o		•	o
EKF 123	111.123.000	226	126	60	204	82	1150	o	o	o	o	o	o		•	o
EKF 161	111.161.000	166	166	60	140	110	1320	o	o	o	o	o	o		•	o
EKF 162	111.162.000	268	168	60	240	110	1880	o	o	o	o	o	o		•	o
EK 081	110.081.000	79	84	67	63	52	320	o	o	o	o	o	o	o	•	o
EK 082	110.082.000	130	85	67	113	52	514	o	o	o	o	o	o	o	•	o
EK 083	110.083.000	180	85	67	163	52	666	o	o	o	o	o	o	o	•	o
EK 121	110.121.000	127	125	90	106	82	1050	o	o	o	o	o	o	o	•	o
EK 123	110.123.000	226	126	90	204	82	1386	o	o	o	o	o	o	o	•	o
EK 161	110.161.000	166	166	100	140	110	1550	o	o	o	o	o	o	o	•	o
EK 162	110.162.000	268	168	100	240	110	2128	o	o	o	o	o	o	o	•	o

Ordering overview conTROL

Type	Art. no.	L	W	H	D	E	g	M	D	A	L	T	S	DH	EMC	67
EKTF 082	311.082.000	130	85	55	113	52	450	o	o	o	o	o	o		•	o
EKTF 083	311.083.000	180	85	55	163	52	600	o	o	o	o	o	o		•	o
EKT 082	310.082.000	130	85	78	113	52	600	o	o	o	o	o	o	o	•	o
EKT 083	310.083.000	180	85	78	163	52	750	o	o	o	o	o	o	o	•	o

• Standard o Optionally available

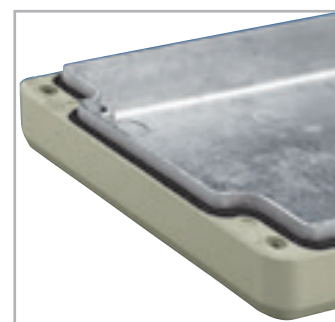

Standard: High inner collar.



Standard: Tooth system in the bottom section for continuous contact.



Exterior hinge.



conTROL version: Cover with high protective collar.

Approvals:



(For conFORM)

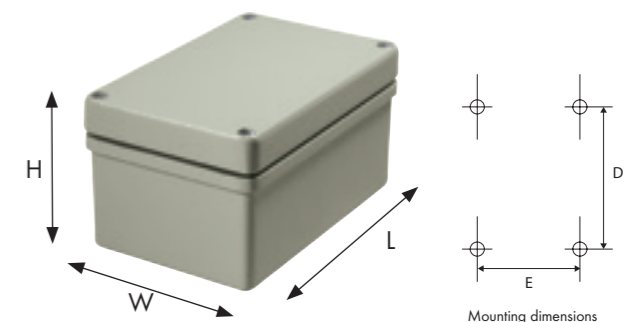

Ingress protection IP 66, optional IP 67

aluTWIN

The two-chamber aluminium enclosure

High-performance aluminium enclosure with twin-chamber system for heavy duty operation. It allows electronic components to be kept separate from the terminal area and thereby protecting them during wiring work.



The key product features:

- Enclosure material: Die-cast aluminium
- Enclosure surface: Lid powder coating RAL 7040, bottom powder coating, RAL 7035
- Secure connection technology due series terminals in a connection space opened separately
- Chambers can be separated by isolation wall
- Lid screws in stainless steel 1.4567
- Ingress protection IP 66
- Enclosure seal: TPE moulded gasket, silicone-free
- Connection space: O-ring gasket (CR)

Ordering overview aluTWIN

Type	Art. no.	L	W	H	D	E	F	g	M	D	A	L	T	S	DV	HS	EMC	67
ATF 100	105.100.000	166	100	55	87	87	40	730	o	o	o	o	o				o	o
AT 100	104.100.000	166	100	81	87	87	40	770	o	o	o	o	o				o	o
AT 160	104.160.000	240	160	103	142	142	103	2170	o	o	o	o	o	o	o	o	o	o
AT 162	104.162.000	240	240	103	222	142	103	3900	o	o	o	o	o	o	o	o	o	o

Ordering overview aluFACE range KTE

Type	Art. no.	L	W	H	D	E	F	g	M	D	S	HS
KTE 160	127.160.000	240	160	120	142	142	103	2150	o	o	o	o
KTE 162	127.162.000	240	240	120	222	142	103	3080	o	o	o	o

• Standard o Optionally available

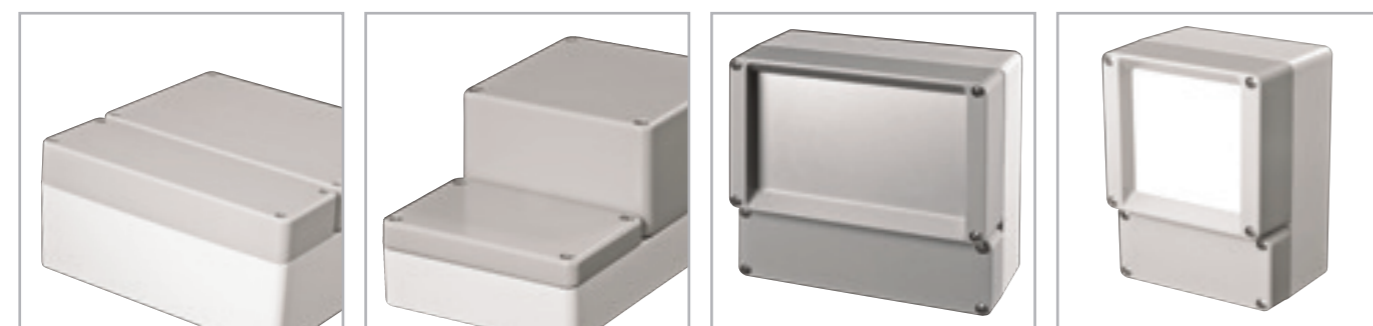

Design with equally high covers.

Design with two heights.

KTE series:

... aluTwin with bezel lid and front panel.

Approvals:

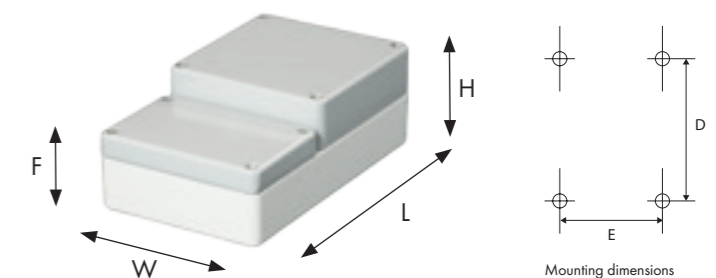

Mounting dimensions

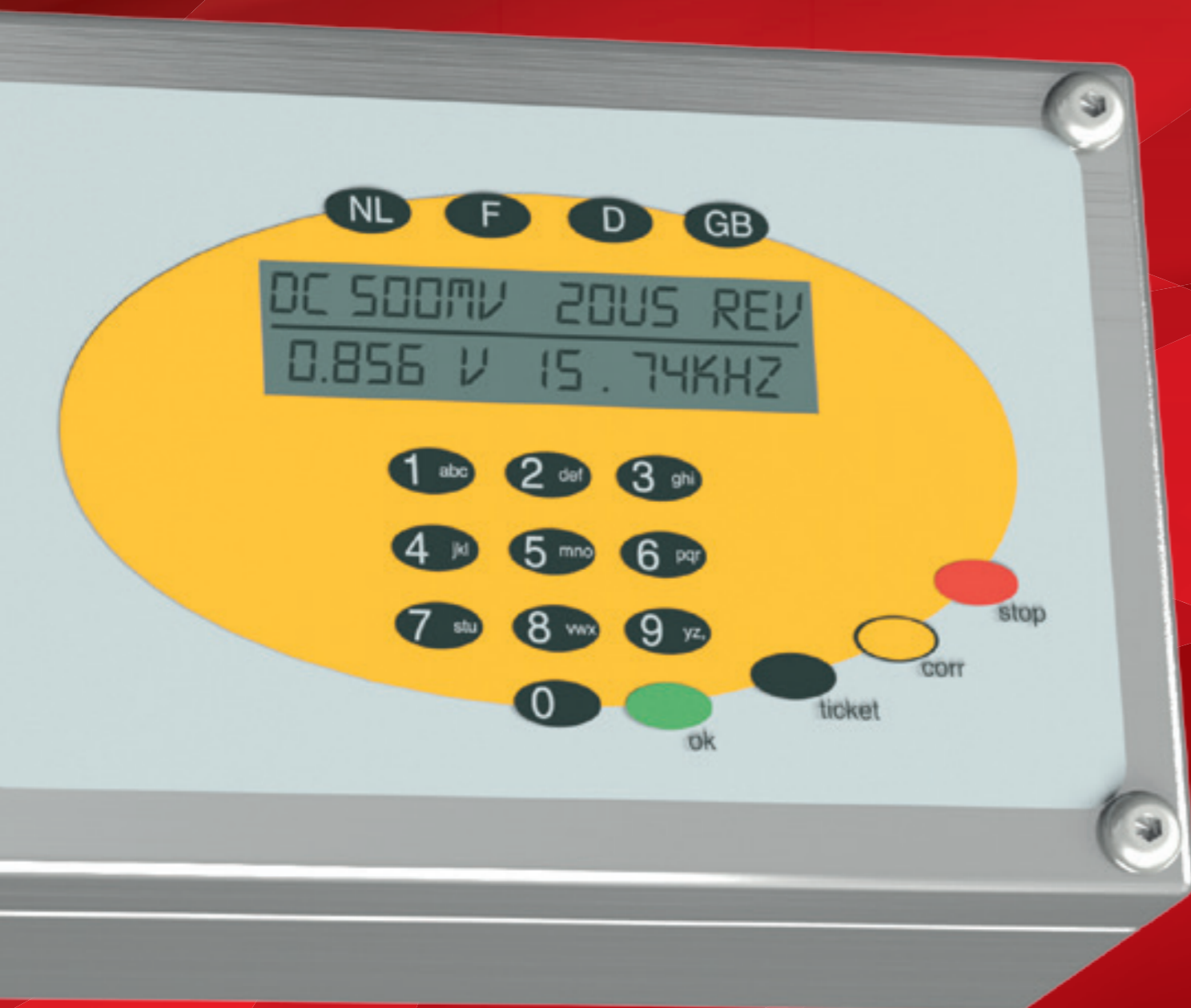

Stainless steel enclosures

High protection for valuable equipment



Ingress protection IP 66/IP 67, optional IP 69K

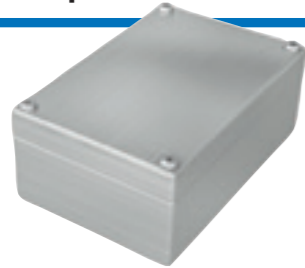

inoCASE A4

Unique stainless steel enclosures

The new standard for industrial electronics enclosures in stainless steel. With captive lid screws. Fastening outside the sealed interior thanks to internal fastening channels.

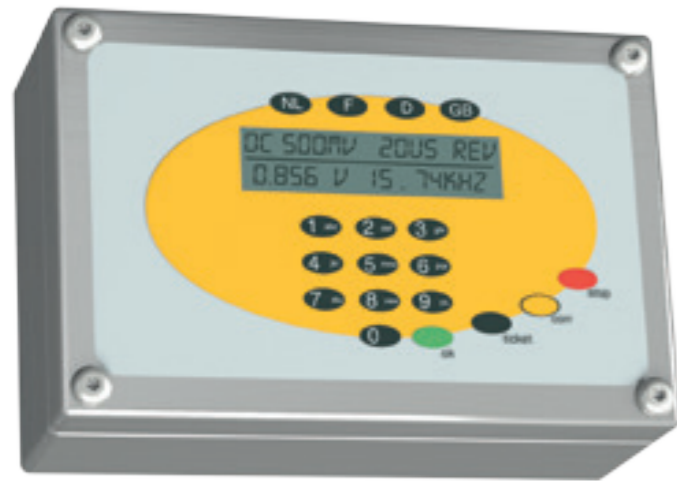

The key product features:

- Enclosure material: A4 sheet stainless steel, 1.4404 (AISI 316L), 1.25 mm sheet thickness
- Applications in a marine environment, resistant to aggressive environmental conditions
- Lid screws in stainless steel 1.4404
- Ingress protection IP 66/IP 67
- Enclosure seal: Silicone gasket

Ordering overview inoCASE A4 stainless steel

Type	Art. no.	L	W	H	D	E	g	M	T	EP	69K
ICC 110	175.110.000	140	110	60	120	90	1020	o	o	o	o
ICC 112	175.112.000	200	110	60	180	90	1180	o	o	o	o
ICC 130	175.130.000	160	130	60	140	110	1100	o	o	o	o
ICC 132	175.132.000	220	130	60	200	110	1358	o	o	o	o
ICCF 150	174.150.000	180	150	60	160	130	1230	o	o	o	o
ICC 150	175.150.000	180	150	90	160	130	1530	o	o	o	o
ICCF 152	174.152.000	260	150	60	240	130	2029	o	o	o	o
ICC 152	175.152.000	260	150	90	240	130	1875	o	o	o	o
ICCF 170	174.170.000	200	170	60	180	150	1680	o	o	o	o
ICC 170	175.170.000	200	170	90	180	150	1750	o	o	o	o
ICCF 172	174.172.000	280	170	60	260	150	1960	o	o	o	o
ICC 172	175.172.000	280	170	90	260	150	2260	o	o	o	o
ICC 200	175.200.000	230	200	120	210	180	2580	o	o	o	o
ICC 202	175.202.000	330	200	120	310	180	3260	o	o	o	o
ICC 250	175.250.000	280	250	120	260	230	3340	o	o	o	o
ICC 252	175.252.000	380	250	120	360	230	4190	o	o	o	o
ICC 300	175.300.000	330	300	120	310	280	4230	o	o	o	o
ICC 302	175.302.000	430	300	120	410	280	5210	o	o	o	o

• Standard o Optionally available



Standard: Surface polished.



Standard: Fastening lugs in the bottom for internal mountings.



Standard: Assembly with fastening channels.



Standard: Earthing bolt in the lid.

Approvals:

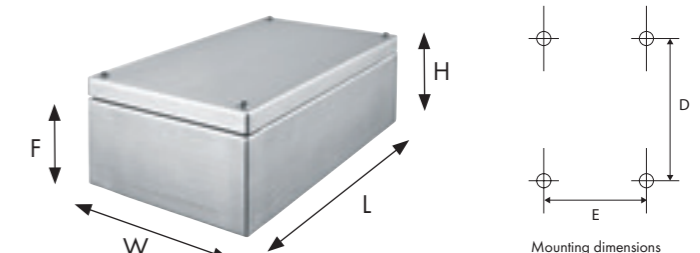

inoBOX A2/A4

The stainless steel standard enclosure

For every type of industrial internal mounting. Spacers are fitted in the bottom for mounting circuit boards, supporting rails or mounting plates. An earthing bolt is also installed in the lid.



The key product features:

- Enclosure material: A2 sheet stainless steel, 1.4301 (AISI 304) or A4, 1.4404 (AISI 316L), 1.2 mm sheet thickness
- Fastening with outer flaps
- Applications in a marine environment, resistant to aggressive environmental conditions
- Ingress protection IP 66
- Enclosure seal: Silicone gasket



Standard: Surface polished.



Standard: Fastening options in the enclosure bottom for internal mountings.

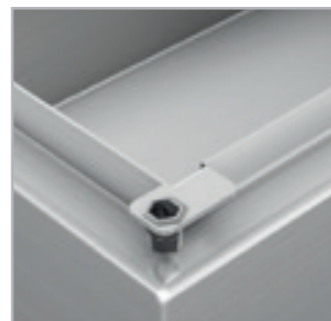

Standard: Plenty of space inside.



Standard: Earthing bolt in the lid.

Ordering overview inoBOX A2 Stainless steel

Type	Art. no.	L	W	H	D	E	g	M	T	Q	A
IB 100	245.100.000	100	100	90	60		900				o
IB 102	245.102.000	150	100	90	110		1100				o
IB 104	245.104.000	200	100	90	160		1300	o	o	o	o
IBF 150	244.150.000	150	150	90	110		1300	o	o	o	o
IB 150	245.150.000	150	150	120	110		1700	o	o	o	o
IBF 154	244.154.000	300	150	90	260		2000	o	o	o	o
IBF 200	244.200.000	200	200	90	160	160	1800	o	o	o	o
IB 200	245.200.000	200	200	120	160	160	2300	o	o	o	o
IBF 202	244.202.000	300	200	90	260	160	2400	o	o	o	o
IB 202	245.202.000	300	200	120	260	160	2900	o	o	o	o
IB 204	245.204.000	400	200	120	360	160	3500	o	o	o	o
IB 252	245.252.000	350	250	120	350	250	3700	o	o	o	o
IB 300	245.300.000	300	300	120	260	260	3700	o	o	o	o
IB 301	245.301.000	400	300	120	360	260	4500	o	o	o	o

Ordering overview inoBOX A4 Stainless steel

Type	Art. no.	L	W	H	D	E	g	M	T	Q	A
IBB 100	247.100.000	100	100	90	60		900				o
IBB 102	247.102.000	150	100	90	110		1100				o
IBB 104	247.104.000	200	100	90	160		1300	o	o	o	o
IBBF 150	246.150.000	150	150	90	110		1300	o	o	o	o
IBB 150	247.150.000	150	150	120	110		1700	o	o	o	o
IBBF 154	246.154.000	300	150	90	260		2000	o	o	o	o
IBBF 200	246.200.000	200	200	90	160	160	1800	o	o	o	o
IBB 200	247.200.000	200	200	120	160	160	2300	o	o	o	o
IBBF 202	246.202.000	300	200	90	260	160	2400	o	o	o	o
IBB 202	247.202.000	300	200	120	260	160	2900	o	o	o	o
IBB 204	247.204.000	400	200	120	360	160	3500	o	o	o	o
IBB 252	247.252.000	350	250	120	350	250	3700	o	o	o	o
IBB 300	247.300.000	300	300	120	260	260	3700	o	o	o	o
IBB 301	247.301.000	400	300	120	360	260	4500	o	o	o	o

• Standard ○ Optionally available

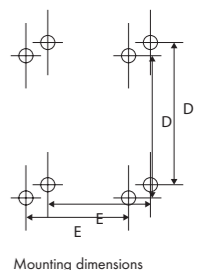
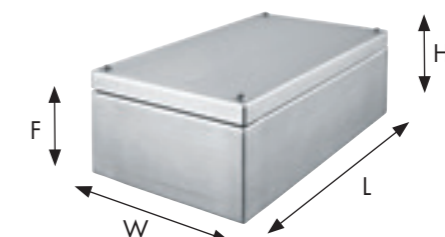

Approvals:



Mounting dimensions



Mobile control enclosures

Handheld enclosures for mobile use



Ingress protection IP 66, optional IP 67



handCASE

The robust handheld enclosure

Thanks to its ergonomic design, the enclosure sits well in your hand. The special wall strength of the enclosure provides robust protection for internal mountings even in the most extreme conditions. The heavy-duty enclosure is available with or without a battery compartment.



The key product features:

- Enclosure material: Die-cast aluminium
- Enclosure surface:
handCASE lid: powder coating, silver-metallic
handCASE bottom: powder coating, RAL 9005
handCASE-R: powder coating, RAL 7035
- Lid screws stainless steel 1.4567
- Integrated recess in cover for membrane keypad or front plate
- Ergonomic design for non-fatiguing work
- Ingress protection IP 66
- Enclosure seal: TPE moulded gasket, silicone-free

Ordering overview handCASE

Type	Art. no.	L	W	H	G	BF	D	EMC	L	IP67
HCF 080	270.080.000	180	80	42.5	450	o	o	o	o	o
HCF 081	270.081.000	180	80	42.5	430		o	o	o	o
HCF 100	270.100.000	220	100	42.5	600	o	o	o	o	o
HC 100	271.100.000	220	100	62.5	660		o	o	o	o



handCASE - Lid with aesthetically ergonomic, tapered recess for a modern look.

Ordering overview handCASE R

Type	Art. no.	L	W	H	G	BF	D	EMC	L	IP67
HCF 080 R	272.080.000	180	80	42.5	450	o	o	o	o	o
HCF 081 R	272.081.000	180	80	42.5	430		o	o	o	o
HCF 100 R	272.100.000	220	100	42.5	600	o	o	o	o	o
HC 100 R	273.100.000	220	100	62.5	660		o	o	o	o



handCASE R - Lid with regular recess for more space on the surface.

• Standard o Optionally available

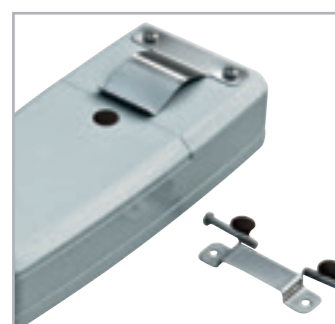

Holding clip and mounting bracket.



Shoulder strap with protective caps for mobile use.



Battery compartment...



...for internal power supply.

Approvals:

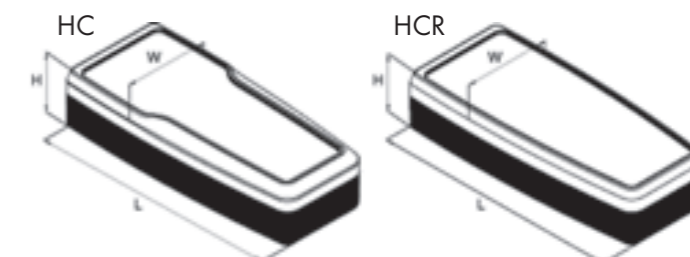

Ingress protection IP 65 or IP 54

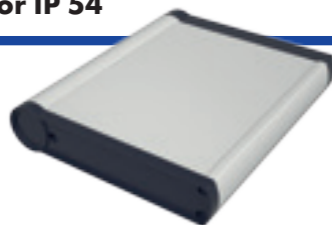

mobilCASE

The mobile extruded control enclosure

The three widths offer scope for every imaginable application. Robust end caps in die-cast aluminium protect the enclosure and internal mountings in mobile field applications. Shoulder straps make transport easier and facilitate operation. Extensive accessories available.



The key product features:

- Enclosure material: Aluminium profile
Lid material: Die-cast zinc
- Enclosure surface: Profile silver-metallic,
Lid RAL 9005
- Lid screws stainless steel 1.4567
- 1-part profile for the insertion of circuit boards
- 2-part profile for the easy assembly of short-stroke keyboards or displays
- Integrated recess for a membrane keypad or front membrane
- Ingress protection: 1-piece profile IP 65;
2-piece profile IP 54
- Lid gasket: TPE moulded gasket, silicone-free
Gasket, 2-part profile: O-ring gasket (CR)

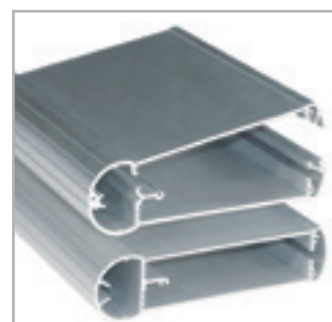

Available as 1-part and 2-part profile.



Articulated wall/desk fixation.



Shoulder strap with protective caps.



Accumulator holder for 2 or 4 AA batteries.

Ordering overview mobilCASE 1-part profile

Type	Art. no.	W	L	P
Profile P 80-1	250.080.120	118	120	80
Profile P 80-1	250.080.160	118	160	80
Profile P 100-1	250.100.160	138	160	100
Profile P 100-1	250.100.200	138	200	100
Profile P 130-1	250.130.180	168	180	130
Profile P 130-1	250.130.240	168	240	130

Type	Art. no.	Size P
Set DF 80	580.080.000	80
Set DF 100	580.100.000	100
Set DF 130	580.130.000	130



DF - 2 flat end covers kit

Type	Art. no.	Size P
Set DK 80	581.080.000	80
Set DK 100	581.100.000	100
Set DK 130	581.130.000	130



DK - 1 flat end cover and 1 deep end cover with screw plug

Type	Art. no.	Connection
Set PG 80-80	588.080.080	Sizes 80+80
Set PG 80-100	588.080.100	Sizes 80+100
Set PG 80-130	588.080.130	Sizes 80+130
Set PG 100-100	588.100.100	Sizes 100+100
Set PG 100-130	588.100.130	Sizes 100+130
Set PG 130-130	588.130.130	Sizes 130+130



PG - Hinged connection kit for 2 profiles

Type	Art. no.	Size P
Set PK 80	583.080.000	80
Set PK 100	583.100.000	100
Set PK 130	583.130.000	130



PK - Shoulder strap with protective caps for mobile utilisation

Type	Art. no.	Size P
Set CH	584.000.000	all sizes



CH - Clip holder for storing the device at wall or machine

Ordering overview mobilCASE 2-part profile

Type	Art. no.	W	L	P
Profile P 80-2	251.080.120	118	120	80
Profile P 80-2	251.080.160	118	160	80
Profile P 100-2	251.100.160	138	160	100
Profile P 100-2	251.100.200	138	200	100
Profile P 130-2	251.130.180	168	180	130
Profile P 130-2	251.130.240	168	240	130

Type	Art. no.	Size P
Set WH 80	589.080.000	80
Set WH 100	589.100.000	100
Set WH 130	589.130.000	130



WH - Pivot mount for wall, machine or desks

Type	Art. no.	Size P
Set ABF 80	589.080.100	80
Set ABF 100	589.100.100	100
Set ABF 130	589.130.100	130
Set ABK 80	589.080.200	80
Set ABK 100	589.100.200	100
Set ABK 130	589.130.200	130



ABF - Tilt stand with flat end covers



ABK - Tilt stand with flat and deep end covers

Type	Art. no.	Sizes P
AH 2	584.002.000	all sizes
AH 4	584.004.000	all sizes
Adapter with cable gland M16	585.000.000	all sizes



Holders for 2 or 4 AA batteries



Adapter with M 16 cable gland

Approvals:

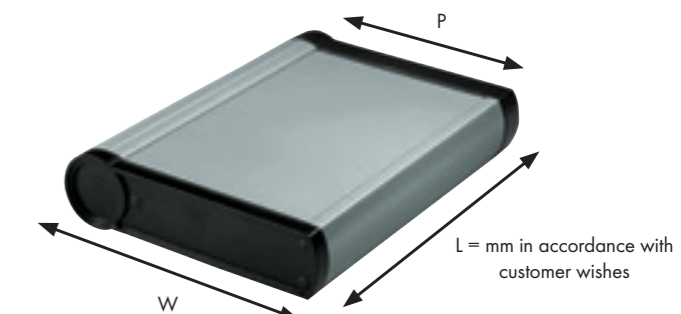

L = mm in accordance with customer wishes

Ingress protection IP 54



aluDISPLAY

The designer extruded display enclosure

The display enclosure comes with a modern design and well-thought out product features. Ideal for electronic controls and operating units with flat modules.



The key product features:

- Enclosure material: Aluminium profile
Lid material: Die-cast aluminium
- Enclosure surface: profile anodised silver, Lid RAL 9005, coupling tube RAL 7035
- Versatile display and operating enclosure for flat modules
- Lid screws stainless steel 1.4567
- Ingress protection IP 54
- Lid gasket: TPE moulded gasket, silicone-free
Profile gasket: O-ring gasket (CR)

Ordering overview aluDISPLAY:

Type	Profile
ADI 180-W	180 mm
ADI 240-W	240 mm
ADI 300-W	300 mm

Supply:
Profile is mounted with wall/
desk fixation on the lid.

Type	Length	Art. no.
K-tube	250 mm	144.400.250
K-tube	500 mm	144.400.500
K-tube	750 mm	144.400.750
K-tube	1000 mm	144.401.000

Supply:
Rotary coupling is mounted on
the tube. Fastening takes place
with 4 screws on the lid.

Type	Length	Art. no.
NK-tube	250 mm	144.410.250
NK-tube	500 mm	144.410.500
NK-tube	750 mm	144.410.750
NK-tube	1000 mm	144.411.000

Supply:
Inclination coupling is mounted to
the tube. Fastening takes place with
4 screws on the lid.



Simple and quick assembly without dismantling the basic enclosure.



Can be used as desk version or on the taraPLUS suspension system.



Internal guide rails for inserting PCBs – only one cover lid has to be removed.



Profile for inserted circuit boards or for assembling internal mountings using spring nuts.

Approvals:

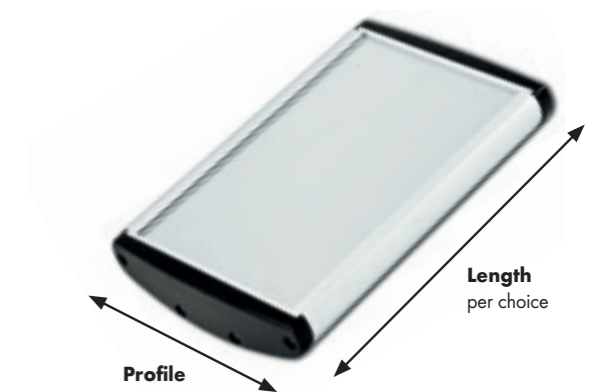



Plastic enclosures

High-quality ASA and ABS - for indoor and outdoor use



Ingress protection IP 66



starCASE

The stylish ASA designer enclosure

Multi-purpose enclosure made from flame-retardant ASA + PC. starCASE is ideally suited for any type of application and is also a perfect enclosure in visual terms thanks to its ergonomic and modern design.



The key product features:

- Enclosure material: ASA + PC
- Enclosure colour similar to RAL 7035
- Lid screws stainless steel 1.4567
- Integrated recess in cover for membrane keypad or front plate
- Design covers to conceal the assembly level
- Fire protection class UL94 V-0
- Ingress protection IP 66
- Enclosure seal: Silicone moulded seal

Ordering overview starCASE

Type	Art. no.	L	W	H	D	E	g	ID	ST	EMC	P
SC 090	230.090.000	120	90	50	99	34	155	•	○	○	○
SC 092	230.092.000	160	90	50	139	34	191	•	○	○	○
SC 110	230.110.000	140	110	60	119	54	232	•	○	○	○
SC 112	230.112.000	200	110	60	179	54	346	•	○	○	○
SC 130	230.130.000	160	130	60	139	74	277	•	○	○	○
SC 132	230.132.000	220	130	60	199	74	382	•	○	○	○
SC 150	230.150.000	180	150	60	159	94	350	•	○	○	○
SC 172	230.172.000	280	170	60	259	114	531	•	○	○	○

• Standard ○ Optionally available



Standard: Integrated lid support.



Standard: The enclosure can be mounted when the lid is fitted.



Sealing set.



Access safeguard by means of insert lock.

Approvals:



Mounting dimensions

Ingress protection IP 66 / optional IP 67



technoDISC

An absolute all-rounder in every respect

The first round ASA + PC enclosure for industrial electronics and electronic components. The cover comes with a recess to accommodate a membrane keypad or a front plate. Enclosure can be mounted when the lid is fitted.



The key product features:

- Enclosure material: ASA + PC
- Enclosure colour similar to RAL 7035
- Lid screws stainless steel 1.4567
- Fire protection class UL94 V-0
- Ingress protection IP 66
- Enclosure seal: Silicone moulded seal

Ordering overview technoDISC

Type	Art. no.	L	W	H	D	E	F	G	g	T	EMC	67
TD 080	285.080.000	110	97	55	87.9	42.3	27.5	7	216	o	o	o
TD 100	285.100.000	130	119	65	98	66	40	30.5	350	o	o	o
TD 120	285.120.000	150	139	80	115	78.5	55	41.5	395	o	o	o
TD 160	285.160.000	190	179	90	154	97	65	60.5	712	o	o	o

• Standard o Optionally available



Standard: Clip-on Design covers.



Standard: The enclosure can be mounted when the lid is fitted.



Standard: Integrated recess to accommodate membrane keypad or front plate.



Standard: Fastening options in the enclosure bottom for internal mountings.

Approvals:

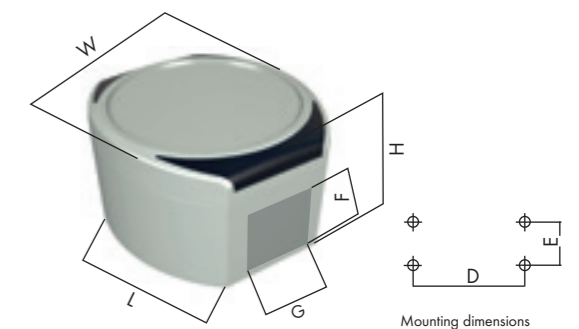

Mounting dimensions

Ingress protection IP 66 / optional IP 67

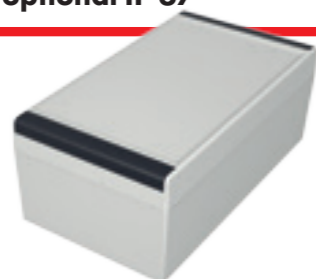

technoPLUS

UV-resistant ASA enclosure

Attractive and modern enclosure made of high quality UV-resistant ASA for electronics applications, especially outdoors. The screw channels are concealed by the clip-in hinged design covers.



The key product features:

- Enclosure material: ASA, UV-stabilised
- Enclosure surface: similar to RAL 7035
- Lid screws stainless steel 1.4567
- Integrated recess in cover for membrane keypad or front plate
- Fire protection class UL94 HB
- Ingress protection IP 66
- Enclosure seal: Silicone moulded gasket

Ordering overview technoPLUS

Type	Art. no.	L	W	H	D	E	g	M	ID	MH	T	EMC	67
TP 090	290.090.000	130	90	70	112	44	260	o	•	o	o	o	o
TP 092	290.092.000	180	90	70	162	44	330	o	•	o	o	o	o
TP 112	290.112.000	160	110	70	142	64	340	o	•	o	o	o	o
TP 132	290.132.000	230	130	90	212	84	580	o	•	o	o	o	o
TP 172	290.172.000	270	170	90	252	124	760	o	•	o	o	o	o



• Standard o Optionally available



Standard: The enclosure can be mounted when the lid is fitted.



Standard: Design covers from PP, RAL 7016



Standard: Integrated lid support.

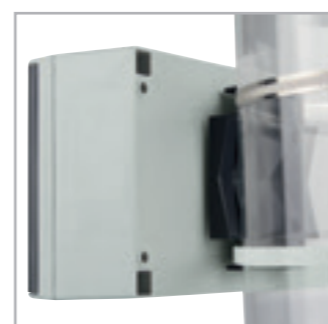

Pole/mast support (Ø30-70 and >70 mm).

Approvals:

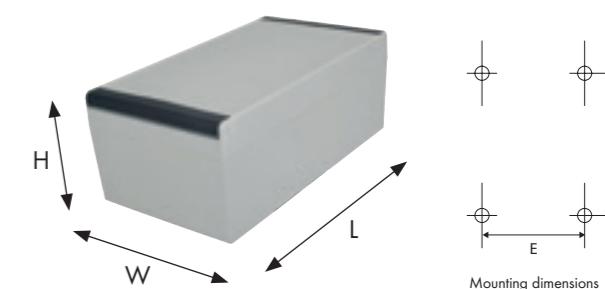

Ingress protection IP 66

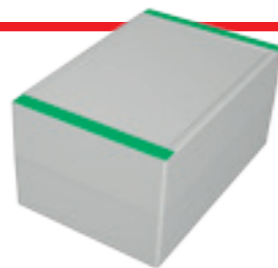

technoCASE

Multi-variable enclosure in ABS

A modern enclosure with a design cover that can be easily snapped on to conceal the screw channels and give the enclosure its own individual appearance. As an alternative, the lid can be used as the bottom and the base can also be used as the lid. This increases the versatility of the enclosures.

The key product features:

- Enclosure material: ABS
- Enclosure surface: similar to RAL 7035
- Lid screws stainless steel 1.4567
- Integrated recess in cover for membrane keypad or front plate
- Fire protection class UL94 HB
- Ingress protection IP 66
- Enclosure seal: Silicone moulded gasket



Ordering overview technoCASE

Type	Art. no.	L	W	H	D	E	g	M	T	F	LH	IS	S	C	P	A	SF
TA 080	201.080.000	80	80	80	66	66	192	o	o	o	o	o	o	o	o	o	o
TA 082	201.082.000	120	80	80	106	66	240	o	o	o	o	o	o	o	o	o	o
TA 084	201.084.000	160	80	80	146	66	286	o	o	o	o	o	o	o	o	o	o
TA 086	201.086.000	240	80	80	226	66	386	o	o	o	o	o	o	o	o	o	o
TA 120	201.120.000	120	120	90	106	106	348	o	o	o	o	o	o	o	o	o	o
TA 122	201.122.000	200	120	90	186	106	484	o	o	o	o	o	o	o	o	o	o
TA 124	201.124.000	240	120	90	226	106	530	o	o	o	o	o	o	o	o	o	o
TA 160	201.160.000	160	160	90	146	146	474	o	o	o	o	o	o	o	o	o	o
TA 162	201.162.000	240	160	90	226	146	620	o	o	o	o	o	o	o	o	o	o
TAH 162	202.162.000	240	160	120	226	146	795	o	o	o	o	o	o	o	o	o	o
TA 202	201.202.000	300	200	120	286	186	1120	o	o	o	o	o	o	o	o	o	o
TAH 202	202.202.000	300	200	160	286	186	1290	o	o	o	o	o	o	o	o	o	o
TA 242	201.242.000	360	240	120	346	226	1500	o	o	o	o	o	o	o	o	o	o
TAH 242	202.242.000	360	240	160	346	226	1730	o	o	o	o	o	o	o	o	o	o
TAF 080	200.080.000	80	80	60	66	66	156	o	o	o	o	o	o	o	o	o	o
TAF 082	200.082.000	120	80	60	106	66	196	o	o	o	o	o	o	o	o	o	o
TAF 084	200.084.000	160	80	60	146	66	234	o	o	o	o	o	o	o	o	o	o
TAF 086	200.086.000	240	80	60	226	66	320	o	o	o	o	o	o	o	o	o	o
TAF 120	200.120.000	120	120	60	106	106	272	o	o	o	o	o	o	o	o	o	o
TAF 122	200.122.000	200	120	60	186	106	398	o	o	o	o	o	o	o	o	o	o
TAF 124	200.124.000	240	120	60	226	106	434	o	o	o	o	o	o	o	o	o	o
TAF 160	200.160.000	160	160	60	146	146	394	o	o	o	o	o	o	o	o	o	o
TAF 162	200.162.000	240	160	60	226	146	534	o	o	o	o	o	o	o	o	o	o
TAF 202	200.202.000	300	200	80	286	186	950	o	o	o	o	o	o	o	o	o	o
TAF 242	200.242.000	360	240	80	346	226	1270	o	o	o	o	o	o	o	o	o	o

• Standard ◦ Optionally available



Standard: Design covers in various colours.



Integrated lid support.



Sealing set.



DIN rail mounting kit

Approvals:

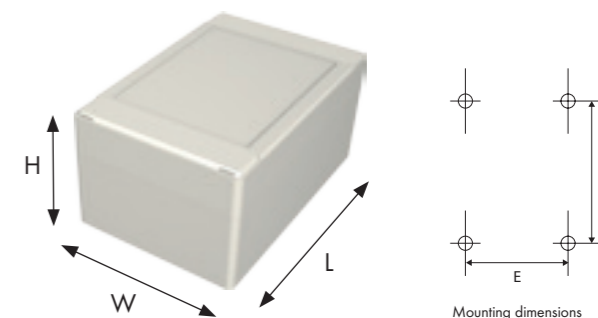

Ingress protection IP 66

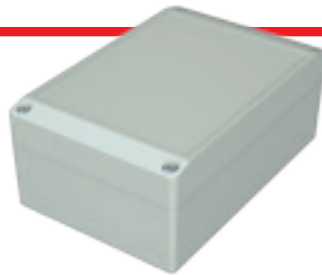

technoBOX

Elegant standard enclosure in ABS

A modern, inexpensive and attractive enclosure for all kinds of electronic and electrical equipment. The slanted lid edges give the enclosure a special appearance.



The key product features:

- Enclosure material: ABS
- Enclosure surface: similar to RAL 7035
- Lid screws stainless steel 1.4567
- Fire protection class UL94 HB
- Ingress protection IP 66
- Enclosure seal: O-ring gasket (CR)

Ordering overview technoBOX

Type	Art. no.	L	W	H	D	E	g	M	T	F	A	S	EMC
TBA 060	220.060.000	66	51	35	53	38	50		o		o		o
TBA 080	220.080.000	83	81	60	70	50	170	o	o	o	o	o	o
TBA 082	220.082.000	121	81	60	108	50	220	o	o	o	o	o	o
TBA 084	220.084.000	161	81	60	148	50	220	o	o	o	o	o	o
TBA 102	220.102.000	151	101	60	138	70	230	o	o	o	o	o	o
TBA 104	220.104.000	201	101	60	188	70	300	o	o	o	o	o	o
TBA 120	220.120.000	123	121	80	110	90	240	o	o	o	o	o	o
TBA 122	220.122.000	201	121	80	188	90	400	o	o	o	o	o	o
TBA 160	220.160.000	161	161	80	148	130	450	o	o	o	o	o	o
TBA 162	220.162.000	241	161	80	228	130	650	o	o	o	o	o	o



• Standard o Optionally available



Standard: Alternative design due to slanted lid edges.



Standard: Integrated recess in the lid for a membrane keypad or front plate.



Exterior hinge.

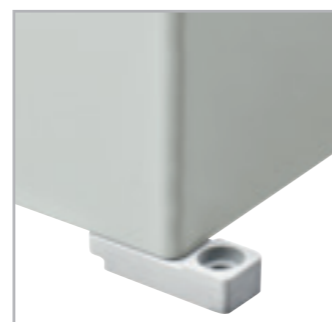

External mounting feet - rotate through 90°.

Approvals:

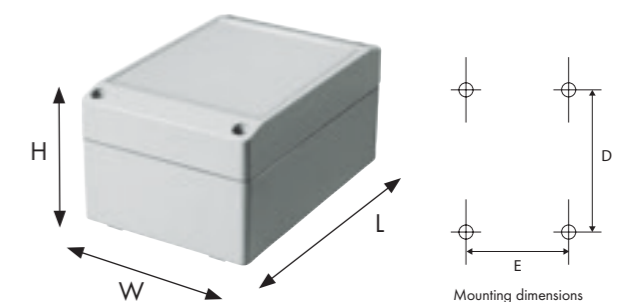

Mounting dimensions

Polyester enclosures

Weather-resistant and functional



Ingress protection IP 66 / optional IP 67



polyTOP

The modular polyester enclosure

Ideal for all types of electronic or electrical equipment thanks to the wide range of standard sizes. Ideal for outdoor applications, as well. The enclosure lid screws are made of corrosion-resistant polyamide and are available in a number of different shapes.



The key product features:

- Enclosure material: glass-fibre reinforced polyester
- Enclosure surface: similar to RAL 7032
- Lid screws in polyamide
- Compatible assembly dimensions with the aluNORM series
- Flammability: UL94 V-0
- Ingress protection IP 66
- Enclosure seal: O-ring gasket (CR)

Ordering overview polyTOP

Type	Art. no.	L	W	H	D	E	g	M	IN	V	W	X	H	S	A	T	67
PT 080	132.080.000	82	82	60	67	67	240	o	o	•					o	o	o
PT 082	132.082.000	122	82	60	107	67	340	o	o	•					o	o	o
PT 084	132.084.000	162	82	60	147	67	420	o	o	•					o	o	o
PT 100	132.100.000	102	102	81	87	87	520	o	o	•				o	o	o	o
PT 102	132.102.000	152	102	81	137	87	650	o	o	•				o	o	o	o
PT 104	132.104.000	202	102	81	187	87	770	o	o	•				o	o	o	o
PT 120	132.120.000	124	124	100	102	102	800	o		•	o	o	o	o	o	o	o
PT 122	132.122.000	184	124	100	162	102	860	o		•	o	o	o	o	o	o	o
PT 124	132.124.000	244	124	100	222	102	920	o		•	o	o	o	o	o	o	o
PT 160	132.160.000	164	164	100	142	142	820	o		•	o	o	o	o	o	o	o
PT 162	132.162.000	244	164	100	222	142	1100	o		•	o	o	o	o	o	o	o
PT 164	132.164.000	324	164	100	302	142	1340	o		•	o	o	o	o	o	o	o
PT 400	132.400.000	404	404	160	382	382	6500	o		•	o	o	o	o	o	o	o

• Standard o Optionally available



External mounting brackets - rotate through 90°.



Large selection of...



...locking plugs.



Exterior hinges.

Approvals:

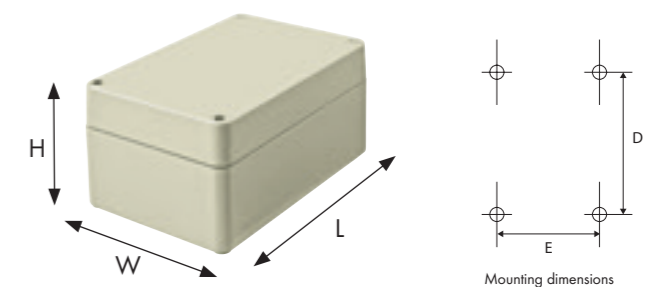

Mounting dimensions

Ingress protection IP 66



polyDOOR

The swing open enclosure

The clever thing about polyDOOR are the integrated hinges for opening the lid. Ideal for outdoor applications. All sizes are also available with a transparent viewing window in the lid.



The key product features:

- Enclosure material: glass-fibre reinforced polyester
- Enclosure surface: similar to RAL 7032
- Lid screws in polyamide
- Flammability: UL94 V-0
- Ingress protection IP 66
- Enclosure seal: O-ring gasket (CR)

Ordering overview polyDOOR

Type	Art. no.	L	W	H	D	E	g	M	V	W	X	H	S	A	T*	Q	FE
PD 120	130.120.000	140	120	100	118	98	850	o	•	o	o	o	•	o	o	o	o
PD 122	130.122.000	200	120	100	178	98	1060	o	•	o	o	o	•	o	o	o	o
PD 124	130.124.000	260	120	100	238	98	1250	o	•	o	o	o	•	o	o	o	o
PD 160	130.160.000	180	160	100	158	138	1180	o	•	o	o	o	•	o	o	o	o
PD 162	130.162.000	260	160	100	238	138	1500	o	•	o	o	o	•	o	o	o	o
PD 164	130.164.000	340	160	100	318	138	1790	o	•	o	o	o	•	o	o	o	o
PD 200	130.200.000	220	200	120	198	178	1800	o	•	o	o	o	•	o	o	o	o
PD 202	130.202.000	320	200	120	298	178	2280	o	•	o	o	o	•	o	o	o	o
PD120FE	131.120.000	140	120	100	118	98	850	o	•	o	o	o	•	o	o	o	o
PD122FE	131.122.000	200	120	100	178	98	1060	o	•	o	o	o	•	o	o	o	o
PD124FE	131.124.000	260	120	100	238	98	1250	o	•	o	o	o	•	o	o	o	o
PD160FE	131.160.000	180	160	100	158	138	1180	o	•	o	o	o	•	o	o	o	o
PD162FE	131.162.000	260	160	100	238	138	1500	o	•	o	o	o	•	o	o	o	o
PD164FE	131.164.000	340	160	100	318	138	1790	o	•	o	o	o	•	o	o	o	o
PD200FE	131.200.000	220	200	120	198	178	1800	o	•	o	o	o	•	o	o	o	o
PD202FE	131.202.000	320	200	120	298	178	2280	o	•	o	o	o	•	o	o	o	o

* T can only be mounted with Q

• Standard o Optionally available



Standard: integrated hinges.



Integrated viewing panel.



Large selection of...



...locking plugs.

Approvals:

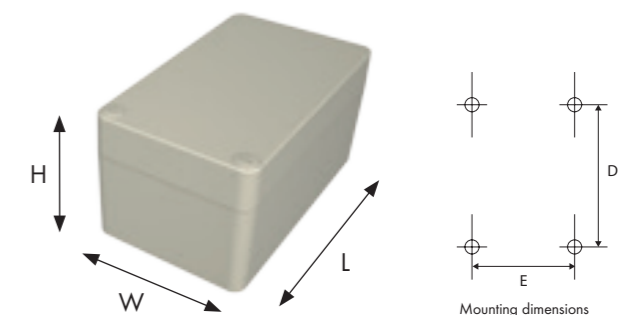

Ingress protection IP 65



polyKOM

Standard polyester enclosure

Weather-resistant polyester. Suitable for all type types of electronic or electrical equipment indoors or outdoors. Compatibility with other common products on the market is another advantage of polyKOM.



The key product features:

- Enclosure material: glass-fibre reinforced polyester
- Enclosure surface: similar to RAL 7000
- Compatible with standard enclosures available on the market, therefore easy to exchange
- Flammability: UL94 V-0
- Lid screws stainless steel 1.4567
- Ingress protection IP 65
- Enclosure seal: O-ring gasket (CR)

Ordering overview polyKOM

Type	Art. no.	L	W	H	D	E	g	M	S	HS	IN	A	D	T
PK 081	180.081.000	80	75	55	68	45	230	o					o	o
PKH 081	182.081.000	80	75	75	68	45	300	o					o	o
PK 082	180.082.000	110	75	55	98	45	295	o					o	o
PK 083	180.083.000	160	75	55	148	45	405	o					o	o
PK 084	180.084.000	190	75	55	178	45	450	o					o	o
PK 121	180.121.000	122	120	90	106	82	750	o	o	o	o	o	o	o
PK 123	180.123.000	220	120	90	204	82	1060	o	o	o	o	o	o	o
PK 161	180.161.000	160	160	90	140	110	1130	o	o	o	o	o	o	o
PK 162	180.162.000	260	160	90	240	110	1710	o	o	o	o	o	o	o
PK 163	180.163.000	360	160	90	340	110	2150	o	o	o	o	o	o	o
PK 164	180.164.000	560	160	90	540	110	3185	o	o	o	o	o	o	o
PK 251	180.251.000	255	250	120	235	200	2650	o	o	o	o	o	o	o
PK 252	180.252.000	400	250	120	380	200	3650	o	o	o	o	o	o	o
PK 254	180.254.000	600	250	120	580	200	5235	o	o	o	o	o	o	o
PK 411	180.411.000	400	405	120	380	355	5580	o	o	o	o	o	o	o

• Standard o Optionally available



External mounting.



Captive Allen lid screw.



Hold hinge.



Exterior hinge.

Approvals:

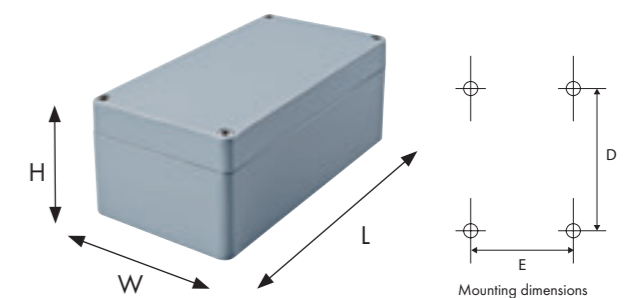

Mounting dimensions



HMI, control and command enclosures

The right solution for machine control



Ingress protection up to IP 65



multiPANEL Display

The designer control/display enclosure

The all-round talent in a purist, multi-variable design. It offers the option of integrating every conceivable application. This version facilitates the permanent installation of a front plate/operating unit or glass front, e.g. for touch screen applications.

The most important product features:

- Enclosure material: Aluminium profiles, Stainless steel decorative inlays
- Enclosure surface: Body and rear wall or doors RAL 9005
- Profile enclosure – high-precision production from 150 x 150 mm to 800 x 800 mm
- Firmly glued aluminium front plate
- 3 enclosure heights: 70, 85 and 130 mm
- Direct access possible with three door designs
- Rear wall bolted (only MPD 00), Lock and hinge RAL 9005
- Connection to the profiPLUS 50 suspension system
- Ingress protection to IP 65
- Enclosure seal: Silicone foam



You can find detailed information on this product in our separate brochure »profiPANEL – multiPANEL – profiPLUS 50/70« and available to download on our website, www.rolec.de

Ordering overview multiPANEL Display												
Type	Art. no.	D	g									
MPD 00 – bolted rear wall	320.000.XXX	70	2466					o	o	o	o	o
MPD 11 – bolted door	320.110.XXX	70	3038	•				o	o	o	o	o
MPD 15 – 15 mm frame door	320.150.XXX	85	3145		•	•		o	o	o	o	o
MPD 60 – 60 mm frame door	320.600.XXX	130	3804		•	•		o	o	o	o	o

• Standard o Optionally available



Standard: Available in three heights.



multiPANEL display – with aluminium front plate or glass front preparation.



Keyboard and mouse holder.



Profile handle.

Approvals:



Ingress protection up to IP 65



multiPANEL Command

The designer command enclosure

The all-round talent in a purist, multi-variable design. It offers the option of integrating every conceivable application. This version allows many commercially available panel PCs or front plates to be directly inserted from the front or back.

The most important product features:

- Enclosure material: Aluminium profiles, Stainless steel decorative inlays
- Enclosure surface: Body and rear wall or doors RAL 9005
- Profile enclosure – high-precision production from 150 x 150 mm to 800 x 800 mm
- Panel PC direct installation or with front or interior insertion of front plate
- 3 enclosure heights: 70, 85 and 130 mm
- Direct access possible with three door designs
- Connection to the profiPLUS 50 suspension system
- Rear wall bolted (only MPK 00), Lock and hinge RAL 9005
- Connection to the profiPLUS 50 suspension system
- Ingress protection to IP 65
- Enclosure seal: Silicone foam



You can find detailed information on this product in our separate brochure »profiPANEL – multiPANEL – profiPLUS 50/70« and available to download on our website, www.rolec.de

Type	Art. no.	D	g	RS	IS	DV	TM	HG	PR	WA	WM
MPK 00 - bolted rear wall	321.000.XXX	70	2466				o	o	o	o	o
MPK 11 - bolted door	321.110.XXX	70	3038	•			o	o	o	o	o
MPK 15 - 15 mm frame door	321.150.XXX	85	3145		•	•	o	o	o	o	o
MPK 60 - 60 mm frame door	321.600.XXX	130	3804		•	•	o	o	o	o	o

Type	Art. no.	D	g	RS	IS	DV	TM	HG	PR	WA	WM
MPK 00 - bolted rear wall	322.000.XXX	70	2466				o	o	o	o	o
MPK 11 - bolted door	322.110.XXX	70	3038	•			o	o	o	o	o
MPK 15 - 15 mm frame door	322.150.XXX	85	3145		•	•	o	o	o	o	o
MPK 60 - 60 mm frame door	322.600.XXX	130	3804		•	•	o	o	o	o	o

* Front plate inserted from the inside

• Standard o Optionally available

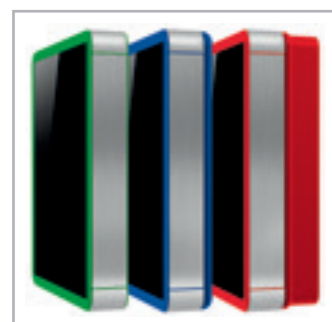

Available in any colour desired.



With front plate inserted from the front or inside.



Handle.



Keyboard holder.

Approvals:



Ingress protection up to IP 65



profiPANEL Standard

The economical version with 90 mm depth

For everyone in a rush, who requires only a small unit quantity or who does not need millimetre-precise dimensions: We have developed the »profiPANEL Standard« for you. Four standard sizes from a 90 mm basic profile with individually configurable front plate into which every panel PC and additional buttons or switches can be incorporated. The rear wall features locks and hinges on the longer sides.



The key product features:

- Enclosure material: Aluminium profiles
PA corner covers, RAL 7035
- Enclosure surface: anodised silver
- Ingress protection to IP 65
- Enclosure seal: EPDM

You can find detailed information on this product in our separate brochure »profiPANEL – multiPANEL – profiPLUS 50/70« and available to download on our website, www.rolec.de

Ordering overview profiPANEL Standard

Type	Art. no.	D	ZL	RS	DV	PR	WM	C
PPD 090 - 400 x 400 mm, 10"-12"	331.090.AAA	90	10"-12"	•	•	○	○	○
PPD 090 - 400 x 520 mm, 12"-15"	331.090.BBB	90	12"-15"	•	•	○	○	○
PPD 090 - 520 x 520 mm, 15"-17"	331.090.CCC	90	15"-17"	•	•	○	○	○
PPD 090 - 520 x 520 mm, 17"-21"	331.090.DDD	90	17"-21"	•	•	○	○	○



• Standard ○ Optionally available

4 simple steps to a perfectly coordinated, economical control enclosure:



1: Select enclosure dimensions based on the planned internal mountings*.



2: Define the machining of the front plate required.



3: Define the position of the suspension arm fixing.



4: On request, select pro handle(s). Possible on the side or at the bottom of the enclosure.



10"-12"

For internal mounting of 10 to 12 inch*
Assignment space:
355 x 355 mm
External dimensions:
400 x 400 mm
Rear wall with locks and hinges



12"-15"

For internal mounting of 12 to 15 inch*
Assignment space:
355 x 475 mm
External dimensions:
400 x 520 mm
Rear wall with locks and hinges



15"-17"

For internal mounting of 15 to 17 inch*
Assignment space:
475 x 475 mm
External dimensions:
520 x 520 mm
Rear wall with locks and hinges



17"-21"

For internal mounting of 17 to 21 inch*
Assignment space:
475 x 555 mm
External dimensions:
520 x 600 mm
Rear wall with locks and hinges

* The internal mounting sizes for panel PCs are intended only as a guideline figure as the manufacturer's air circulation values also need to be taken into consideration.

Ingress protection up to IP 65



profiPANEL Individual

The modern HMI/control enclosure series

Thanks to the option of combining three basic profile widths, it is possible to realise a total of 8 individual mounting depths. In this way, almost every conceivable configuration for the internal mounting of components can be realised. The design facilitates almost seamless, flush installation of the front plate, which is permanently connected with the enclosure. Appropriate cut-outs for a display, switches, etc. are included in the service provided by ROLEC and are produced ex-works to meet customer specifications.

You can find detailed information on this product in our separate brochure »profiPANEL – multiPANEL – profiPLUS 50/70« and available to download on our website, www.rolec.de



The key product features:

- Enclosure material: Aluminium profiles
- Enclosure surface: anodised silver
- Profile enclosure – manufactured to measure from depths of 60 mm to 300 mm
- Direct access through doors with locks and hinges (on the longer side as standard)
- Ingress protection to IP 65
- Enclosure seal: EPDM

Ordering overview profiPANEL

Type	Art. no.	D	RS	DV	VR	PR	TM	P60	P90	WA	WM	C
PPD 60 Basic	330.060.AAA	60	•	•	○	○	○	○	○	○	○	○
PPD 90 Basic	330.090.AAA	90	•	•	○	○	○	○	○	○	○	○
PPD 120 (Combi 60/60)	332.120.AAA	120	•	•	○	○	○	○	○	○	○	○
PPD 150 Basic	330.150.AAA	150	•	•	○	○	○	○	○	○	○	○
PPD 150 (Combi 90/60)	332.150.AAA	150	•	•	○	○	○	○	○	○	○	○
PPD 180 (Combi 90/90)	332.180.AAA	180	•	•	○	○	○	○	○	○	○	○
PPD 210 (Combi 150/60)	332.210.AAA	210	•	•	○	○	○	○	○	○	○	○
PPD 240 (Combi 150/90)	332.240.AAA	240	•	•	○	○	○	○	○	○	○	○
PPD 300 (Combi 150/150)	332.300.AAA	300	•	•	○	○	○	○	○	○	○	○

• Standard ○ Optionally available



Wall connection with left and right stop possible.



Profile handles possible on the side or bottom of the enclosure.



Keyboard holder.



Coloured corners alternatively in RAL 3020, 5017 or 9005.

Approvals:



Ingress protection IP 66



commandCASE

The economic command enclosure

A functional, robust, economical and elegant control enclosure for electrical and electronic equipment. A recess in the lid can accommodate a membrane keypad, front plates or operating panel.

The key product features:

- Enclosure material: Die-cast aluminium
- Enclosure surface: powder coating, RAL 7035
- Connection to the suspension systems profiPLUS or taraPLUS
- Integrated recess in cover for membrane keypad or front plate
- Ingress protection IP 66
- Enclosure seal: O-ring gasket (CR)



Ordering overview commandCASE Standard

Type	Art. no.	L	W	H	D	E	g	SV	SZ	S	L	D	EMC
CC 200	193.200.000	230	200	120	212	144	2466	•	○	•	○	○	○
CC 202	193.202.000	330	200	120	312	144	3038	•	○	•	○	○	○
CC 250	193.250.000	280	250	120	262	194	3145	•	○	•	○	○	○
CC 252	193.252.000	380	250	120	362	194	3804	•	○	•	○	○	○
CC 300	193.300.000	330	300	120	312	244	4134	•	○	•	○	○	○
CC 302	193.302.000	430	300	120	412	244	4872	•	○	•	○	○	○



Standard: Quick-acting closure and hinges, narrow side

Ordering overview commandCASE version 1

Type	Art. no.	L	W	H	D	E	g	S	L	D	EMC
CCS 200	194.200.000	230	200	120	212	144	2466	•	○	○	○
CCS 202	194.202.000	330	200	120	312	144	3038	•	○	○	○
CCS 250	194.250.000	280	250	120	262	194	3145	•	○	○	○
CCS 252	194.252.000	380	250	120	362	194	3804	•	○	○	○
CCS 300	194.300.000	330	300	120	312	244	4134	•	○	○	○
CCS 302	194.302.000	430	300	120	412	244	4872	•	○	○	○



Version 1: Bolted with hinges

Ordering overview commandCASE version 2

Type	Art. no.	L	W	H	D	E	g	ID	L	D	EMC
CCV 200	195.200.000	230	200	120	212	144	2466	•	○	○	○
CCV 202	195.202.000	330	200	120	312	144	3038	•	○	○	○
CCV 250	195.250.000	280	250	120	262	194	3145	•	○	○	○
CCV 252	195.252.000	380	250	120	362	194	3804	•	○	○	○
CCV 300	195.300.000	330	300	120	312	244	4134	•	○	○	○
CCV 302	195.302.000	430	300	120	412	244	4872	•	○	○	○



Version 2: Bolted

• Standard ○ Optionally available



Standard: Ergonomically shaped design handle bars.



Practical quick-acting closure. Lockable or non-lockable.



Version 1: Bolted on the rear with hinges.



Version 2: Bolted on the rear.

Approvals:

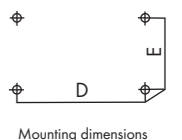
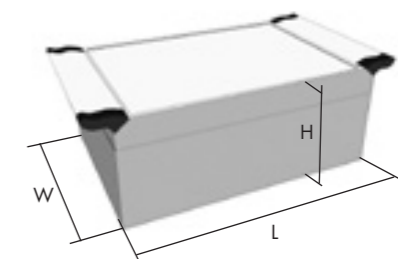

Mounting dimensions

Ingress protection IP 65

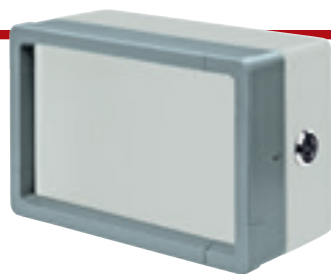

aluFACE

The reliable front plate enclosure

An extremely versatile and flexible command enclosure. Ideal for all types of industrial operating and display technology.



The most important product features:

- Enclosure material: Die-cast aluminium
Framework: Corner pieces from die-cast zinc and aluminium profiles
Front plate: 3 mm aluminium, anodised silver
- Enclosure surface: powder coating, RAL 7040/7035
- Single-channel mounting for greater installation volume
- Ideal connection to the suspension systems taraPLUS and profiPLUS
- Lid screws stainless steel 1.4567
- Ingress protection IP 65
- Enclosure seal: TPE moulded gasket, silicone-free
O-ring gasket (CR)
Profile seal (CR)

Ordering overview aluFACE range KCE



Type	Art. no.	L	W	H	D	E	g	M	S	DV	W	X	Y	Z	J	I
KCE 120	119.120.000	120	120	114	102	102	1590	o	•	•	o	o	o	o		
KCE 122	119.122.000	180	120	114	162	102	1820	o	•	•	o	o	o	o		
KCE 124	119.124.000	240	120	114	222	102	2170	o	•	•	o	o	o	o		
KCE 160	119.160.000	160	160	114	142	142	2060	o	•	•	o	o	o	o	o	
KCE 162	119.162.000	240	160	114	222	142	2650	o	•	•	o	o	o	o	o	
KCE 164	119.164.000	320	160	114	302	142	3190	o	•	•	o	o	o	o	o	
KCE 166	119.166.000	480	160	114	462	142	4710	o	•	•	o	o	o	o	o	
KCE 200	119.200.000	200	200	135	180	180	3150	o	•	•	o	o	o	o	o	o
KCE 202	119.202.000	300	200	135	280	180	3680	o	•	•	o	o	o	o	o	o
KCE 204	119.204.000	400	200	135	380	180	5480	o	•	•	o	o	o	o	o	o
KCE 240	119.240.000	240	240	135	220	220	4110	o	•	•	o	o	o	o	o	o
KCE 242	119.242.000	360	240	135	340	220	4800	o	•	•	o	o	o	o	o	o
KCE 244	119.244.000	480	240	135	460	220	6950	o	•	•	o	o	o	o	o	o
KCE 320	119.320.000	320	320	135	300	300	5720	o	•	•	o	o	o	o	o	o
KCE 322	119.322.000	480	320	135	460	300	7530	o	•	•	o	o	o	o	o	o
KCE 324	119.324.000	640	320	135	620	300	9720	o	•	•	o	o	o	o	o	o

• Standard o Optionally available

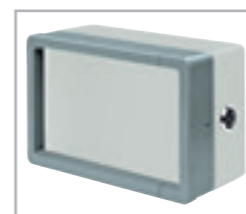

aluFACE range KCE - Flat framework, two-piece lid

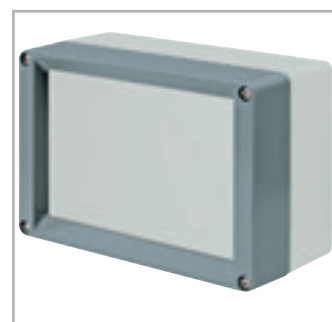

KE: 1-piece framework.



KCE/KSE: 2-piece lid with flat or high framework, integrated lock and hinges.

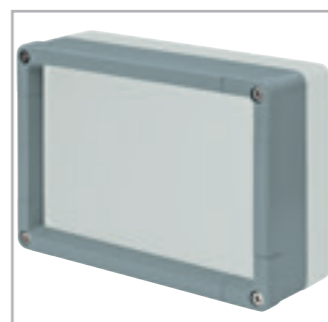

KVE/KVF: 2-piece lid with flat framework and bottom.

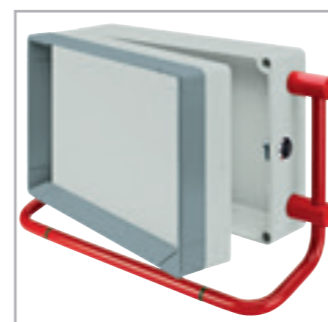

Handle system in RAL 3020 or RAL 9005.

Approvals:

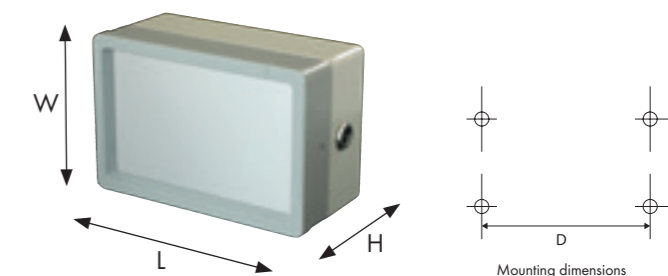

Mounting dimensions

Ordering overview aluFACE range KSE

Type	Art. no.	L	W	H	D	E	g	M	S	DV	W	X	Y	Z	J	I	A
KSE 160	115.160.000	160	160	133.5	142	142	2360	○	•	•	○	○	○	○	○	○	○
KSE 162	115.162.000	240	160	133.5	222	142	2960	○	•	•	○	○	○	○	○	○	○
KSE 164	115.164.000	320	160	133.5	302	142	3530	○	•	•	○	○	○	○	○	○	○
KSE 166	115.166.000	480	160	133.5	462	142	5090	○	•	•	○	○	○	○	○	○	○
KSE 200	115.200.000	200	200	153.5	180	180	3460	○	•	•	○	○	○	○	○	○	○
KSE 202	115.202.000	300	200	153.5	280	180	4320	○	•	•	○	○	○	○	○	○	○
KSE 204	115.204.000	400	200	153.5	380	180	5860	○	•	•	○	○	○	○	○	○	○
KSE 240	115.240.000	240	240	153.5	220	220	4450	○	•	•	○	○	○	○	○	○	○
KSE 242	115.242.000	360	240	153.5	340	220	5160	○	•	•	○	○	○	○	○	○	○
KSE 244	115.244.000	480	240	153.5	460	220	7350	○	•	•	○	○	○	○	○	○	○
KSE 320	115.320.000	320	320	153.5	300	300	6100	○	•	•	○	○	○	○	○	○	○
KSE 322	115.322.000	480	320	153.5	460	300	7950	○	•	•	○	○	○	○	○	○	○
KSE 324	115.324.000	640	320	153.5	620	300	10180	○	•	•	○	○	○	○	○	○	○

• Standard ○ Optionally available



aluFACE range KSE - High framework, two-piece lid

Ordering overview aluFACE range KE

Type	Art. no.	L	W	H	D	E	g	M	S	HS	D	V	W	X	Y	Z	J	I	A	
KE 160	126.160.000	160	160	117	142	142	1330	○	○	○	○	○	○	○	○	○	○	○	○	○
KE 162	126.162.000	240	160	117	222	142	1920	○	○	○	○	○	○	○	○	○	○	○	○	○
KE 242	126.242.000	360	240	137	340	220	4600	○	○	○	○	○	○	○	○	○	○	○	○	○

• Standard ○ Optionally available



aluFACE range KE - Framework, single-piece aluminium frame

Ordering overview aluFACE range KVF

Type	Art. no.	L	W	H	D	E	g	M	S	HS	J	A
KVF 120	123.120.000	120	120	80	102	102	1200	○	○	○	○	○
KVF 122	123.122.000	180	120	80	162	102	1400	○	○	○	○	○
KVF 124	123.124.000	240	120	80	222	102	1690	○	○	○	○	○
KVF 160	123.160.000	160	160	80	142	142	1740	○	○	○	○	○
KVF 162	123.162.000	240	160	80	222	142	2230	○	○	○	○	○
KVF 164	123.164.000	320	160	80	302	142	2700	○	○	○	○	○
KVF 166	123.166.000	480	160	80	462	142	3990	○	○	○	○	○
KVF 200	123.200.000	200	200	95	180	180	2640	○	○	○	○	○
KVF 202	123.202.000	300	200	95	280	180	3350	○	○	○	○	○
KVF 204	123.204.000	400	200	95	380	180	4620	○	○	○	○	○
KVF 240	123.240.000	240	240	95	220	220	3460	○	○	○	○	○
KVF 242	123.242.000	360	240	95	340	220	4950	○	○	○	○	○
KVF 244	123.244.000	480	240	95	460	220	5850	○	○	○	○	○
KVF 320	123.320.000	320	320	95	300	300	4820	○	○	○	○	○
KVF 322	123.322.000	480	320	95	460	300	6340	○	○	○	○	○
KVF 324	123.324.000	640	320	95	620	300	8170	○	○	○	○	○

• Standard ○ Optionally available



aluFACE range KVF - Flat framework, flat bottom, bolted

Ordering overview aluFACE range KVE

Type	Art. no.	L	W	H	D	E	g	M	S	HS	J	I	A
KVE 120	125.120.000	120	120	114	102	102	1390	○	○	○	○	○	○
KVE 122	125.122.000	180	120	114	162	102	1610	○	○	○	○	○	○
KVE 124	125.124.000	240	120	114	222	102	1970	○	○	○	○	○	○
KVE 160	125.160.000	160	160	114	142	142	1860	○	○	○	○	○	○
KVE 162	125.162.000	240	160	114	222	142	2440	○	○	○	○	○	○
KVE 164	125.164.000	320	160	114	302	142	2990	○	○	○	○	○	○
KVE 166	125.166.000	480	160	114	462	142	4500	○	○	○	○	○	○
KVE 200	125.200.000	200	200	135	180	180	2950	○	○	○	○	○	○
KVE 202	125.202.000	300	200	135	280	180	3470	○	○	○	○	○	○
KVE 204	125.204.000	400	200	135	380	180	5270	○	○	○	○	○	○
KVE 240	125.240.000	240	240	135	220	220	3900	○	○	○	○	○	○
KVE 242	125.242.000	360	240	135	340	220	4600	○	○	○	○	○	○
KVE 244	125.244.000	480	240	135	460	220	6740	○	○	○	○	○	○
KVE 320	125.320.000	320	320	135	300	300	5510	○	○	○	○	○	○
KVE 322	125.322.000	480	320	135	460	300	7320	○	○	○	○	○	○
KVE 324	125.324.000	640	320	135	620	300	9510	○	○	○	○	○	○

• Standard ○ Optionally available

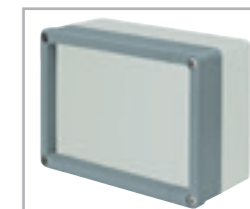

aluFACE range KVE - Flat framework, high bottom, bolted

Ingress protection IP 65



multiVISION Display

The variable control/display enclosure

Ideal as display enclosure for indoor and outdoor use thanks to ingress protection IP 65. Can also be used as a control enclosure.



The key product features:

- Enclosure material: Die-cast aluminium and aluminium profiles
- Enclosure surface: powder coating, RAL 7040
- Assembly of front plates without visible screws
- Ingress protection IP 65
- Enclosure seal: O-ring gasket (CR), Profile seal (CR)

Ordering overview multiVISION Display

Type	Profile	Dimensions in mm	M	RS*	S	DV	W	X	Y	Z	I
MVD 01	D1	60	o	o			o	o	o	o	o
MVD 02	D2	120	o	o			o	o	o	o	o
MVD 03	D3	60/60	o		•	•	o	o	o	o	o
MVD 04	D4	60/120	o		•	•	o	o	o	o	o
MVD 05	D5	120/120	o		•	•	o	o	o	o	o
MVD 06	D6	180	o	o			o	o	o	o	o
MVD 07	D7	60/180	o		•	•	o	o	o	o	o
MVD 08	D8	120/180	o		•	•	o	o	o	o	o
MVD 09	D9	180/180	o		•	•	o	o	o	o	o

*RS with DV as standard

• Standard o Optionally available



One-piece profile, back panel with hinge and lock.



Two-piece profile (e.g. 120/60) with lock and hinge.

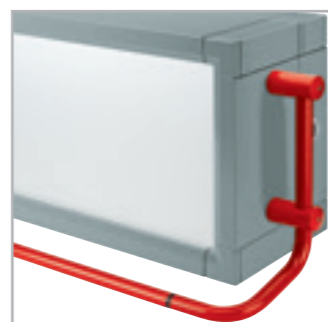

Handle system available in RAL 3020 or RAL 9005.



Connection to all ROLEC suspension systems possible.

Approvals:



Profile combination

F = Front plate R = Rear wall

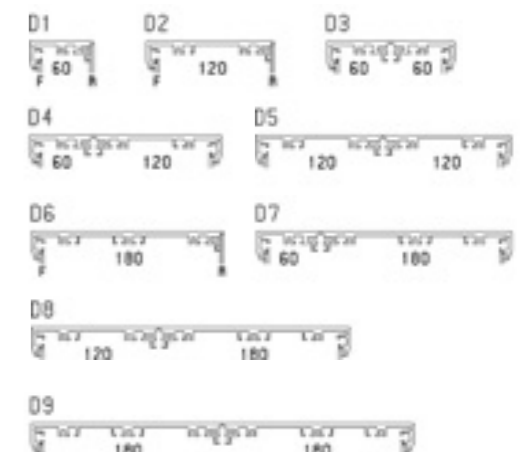

Ingress protection IP 65



multiVISION Command

The variable command enclosure

The body of the main profile was developed with a cooling element look for design reasons. The combination of three different profiles offers a great deal of space for internal equipment.



The key product features:

- Enclosure material: Die-cast aluminium and aluminium profiles
- Enclosure surface: powder coating, RAL 7040
- Assembly of front plates without visible screws
- Ingress protection IP 65
- Enclosure seal: O-ring gasket (CR)
Profile seal (CR)

Ordering overview
multiVISION Command



Type	Profile	M	RS*	S	DV	W	X	Y	Z	I
MVK 01	K1	o	o			o	o	o	o	o
MVK 02	K2	o		•	•	o	o	o	o	o
MVK 03	K3	o		•	•	o	o	o	o	o
MVK 04	K4	o		•	•	o	o	o	o	o

*RS with DV as standard

• Standard o Optionally available

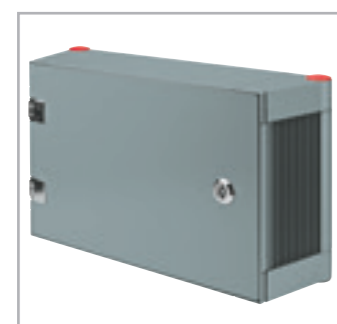

One-piece profile, back panel with hinge and lock.



Two-piece profile (e.g. 120/120) with lock and hinge.



Two-piece profile (e.g. 120/60).



multiVISION Kommando: handle system possible for every size.

Profile combination

F = Front plate R = Rear wall

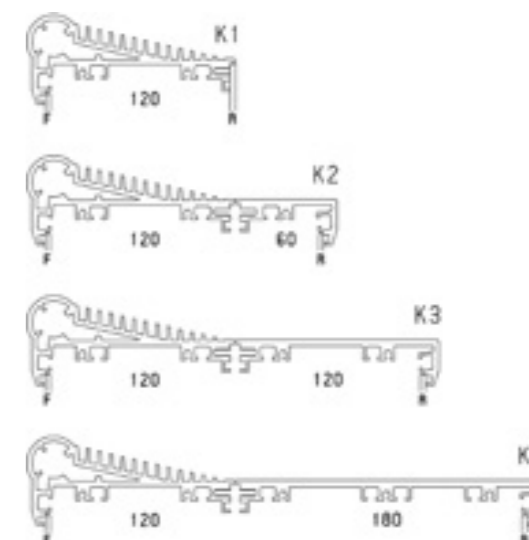

Approvals:





Suspension systems

For connecting control systems perfectly

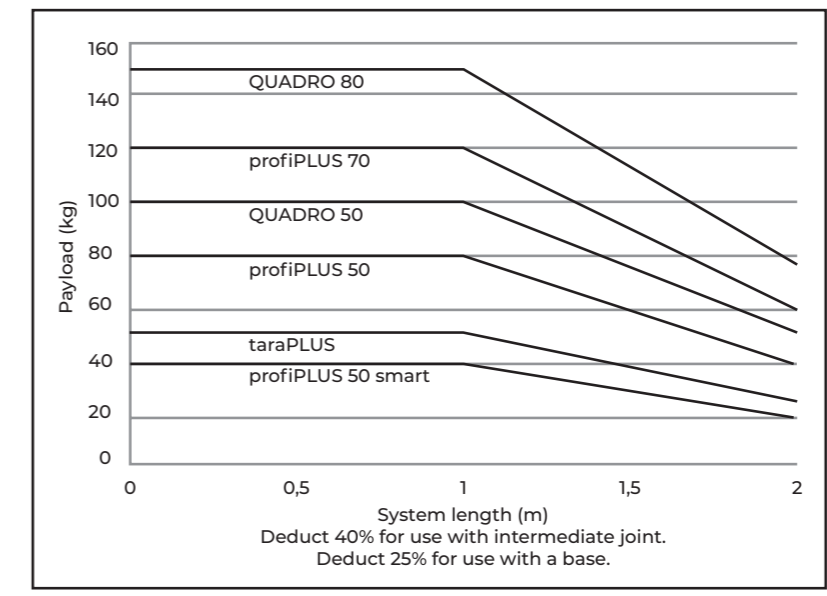
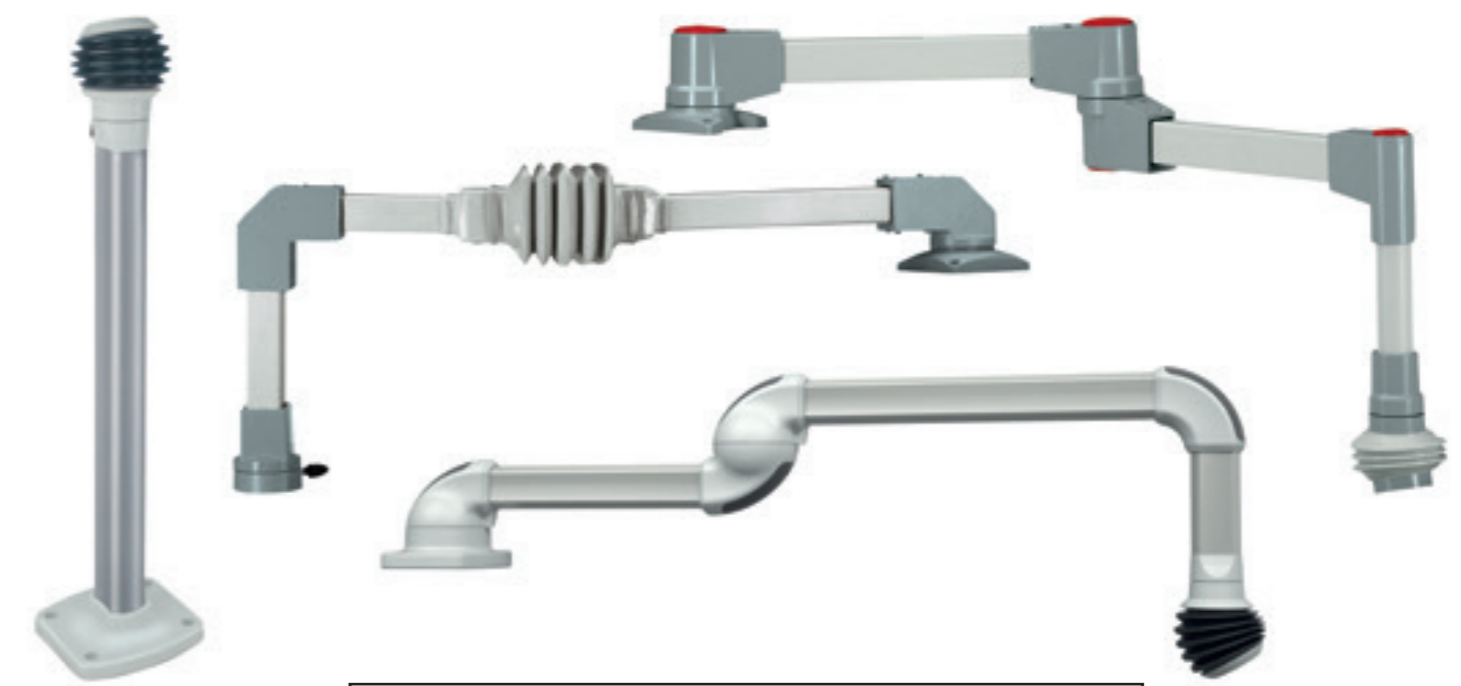

Ingress protection IP 54



profiPLUS 50

The designer suspension system

The design harmonises perfectly with that of machinery. Time-saving assembly, a range of system components and numerous panel adapters for connecting panel PCs from leading vendors give the system an unrivalled advantage.

The key product features:

- System parts material: Die-cast aluminium, powder coating, RAL 7035
- Suspension profile material: Aluminium profile, in anodised silver
- Matching adapters, e.g. for Beckhoff, Siemens, B&R and further panel manufacturers
- Many couplings with pre-fitted suspension profile as standard
- Can be used with all ROLEC control enclosures; the perfect complement to 'multiPANEL' and 'profiPANEL'
- Possible to route connectors such as HDMI, DVI, network adapters, etc.
- Integrated cable protection
- Ingress protection IP 54
- Gasket: Chloroprene (CR)



Whether profiPLUS 50 or 70: both systems offer sufficient space for cable routing.



Simple height adjustment with patented 'screw adjustment'.



End-to-end potential equalisation to protect humans and equipment.



Matching adapters, e.g. for Siemens, Beckhoff, B&R.

System components	Art. no.	Hanging	Upright	Pivoting	Horizontally adjusting	Adjustable	Support profile length* mm	Weight / g
Coupling **	142.240.250		•	•			250	1450
	142.240.500		•	•			500	2350
	142.240.750		•	•			750	3250
	142.241.000			•	•		1000	4150
	142.250.250	•		•			250	1450
	142.250.500	•		•			500	2350
	142.250.750	•		•			750	3250
	142.251.000	•		•			1000	4.150
Coupling A **	142.260.250		•	•		•	250	2520
	142.260.500		•	•		•	500	3420
	142.260.750		•	•		•	750	4320
	142.261.000			•	•		1000	5220
	142.270.250	•		•		•	250	2520
	142.270.500	•		•		•	500	3520
	142.270.750	•		•		•	750	4320
	142.271.000	•		•		•	1000	5.220
Console coupling A **	142.280.250		•	•		•	250	3390
	142.280.500		•	•		•	500	4290
	142.280.750		•	•		•	750	5190
	142.281.000			•	•		1000	6090
	142.290.250	•		•		•	250	3390
	142.290.500	•		•		•	500	4290
	142.290.750	•		•		•	750	5190
	142.291.000	•		•		•	1000	6.090
Elbow coupling	142.034.000		•	•				1260
	142.035.000	•		•				1260
Elbow coupling A	142.036.000		•	•		•		2370
	142.037.000	•		•		•		2370
Elbow console coupling A	142.038.000		•	•		•		3240
	142.039.000	•		•		•		3240
Elbow panel coupling	142.040.000		•	•				1630
	142.041.000	•		•				1630
Elbow panel coupling A	142.042.000		•	•		•		2410
	142.043.000	•		•		•		2410

*For explanation see following page

Approvals:



System components	Art. no.	Hanging	Upright	Pivoting	Horizontally adjusting	Adjustable	Support profile length* mm	Weight / g
Panel coupling	142.220.250		•	•			250	1750
	142.220.500		•	•			500	2650
	142.220.750		•	•			750	3550
	142.221.000		•	•			1000	4450
	142.230.250	•		•			250	1750
	142.230.500	•		•			500	2650
	142.230.750	•		•			750	3550
	142.231.000	•		•			1000	4450
	Panel coupling A	142.300.250	•		•		•	250
142.300.500		•		•		•	500	3620
142.300.750		•		•		•	750	4520
142.301.000		•		•		•	1000	5420
142.310.250			•	•		•	250	2720
142.310.500			•	•		•	500	3620
142.310.750			•	•		•	750	4520
142.311.000		•	•		•	1000	5420	
Wall joint, horizontal	142.010.000		•	•	•			5350
Wall joint, vertical	142.010.001			•				5170
Smart wall joint	142.010.200			•	•			2816
Socket joint	142.005.000			•	•			4450
Socket joint, vertical	142.005.001		•	•				4100
Smart socket joint	142.005.200			•	•			1976
Wall connection profiPANEL	501.100.300			•				1593
Wall connection multiPANEL	501.100.200			•				1593
Elbow	142.020.000	•	•					750
Intermediate joint	142.015.000			•	•			4050
Mobile base	142.030.150		•	•				26000
Mobile base	142.030.160		•	•				10000
Roller set	501.142.000		•	•				
Base ***	142.030.000	•	•					1350
Support profile 250 mm	142.000.250						250	900
Support profile 500 mm	142.000.500						500	1800
Support profile 750 mm	142.000.750						750	2700
Support profile 1000 mm	142.001.000						1000	3600
Support profile 1500 mm	142.001.500						1500	5400
B&R adaptor Ø48 profile	142.000.003	•	•					435
VESA adaptor	142.000.005	•	•			•		2085
B&R adaptor Ø48 / 62,5	142.000.008	•	•					641

System components	Art. no.	Hanging	Upright	Pivoting	Horizontally adjusting	Adjustable	Support profile length* mm	Weight / g
50/48 adaptor including elbow	142.020.001	•	•					1250
Elbow coupling 50/48	142.020.002	•	•	•				2150
50/48 adaptor	142.024.100	•	•					500
Smart wall joint profile adaptor	142.024.200							211
Smart socket joint profile adaptor	142.024.300							534
Smart wall joint universal adaptor	142.025.XXX							
Smart socket joint universal adaptor	142.026.XXX							
Siemens adaptor	142.024.000	•	•					110
70/50 adaptor	143.000.001	•	•					370
Signal light adaptor, joint	142.020.501							150
Signal light adaptor, elbow	142.020.502							180
Beckhoff adaptor Ø 48	142.000.000	•	•					340

- Functional features
- * Special lengths available on request
- ** Delivery with support profile fitted
- *** Horizontal and vertical installation possible

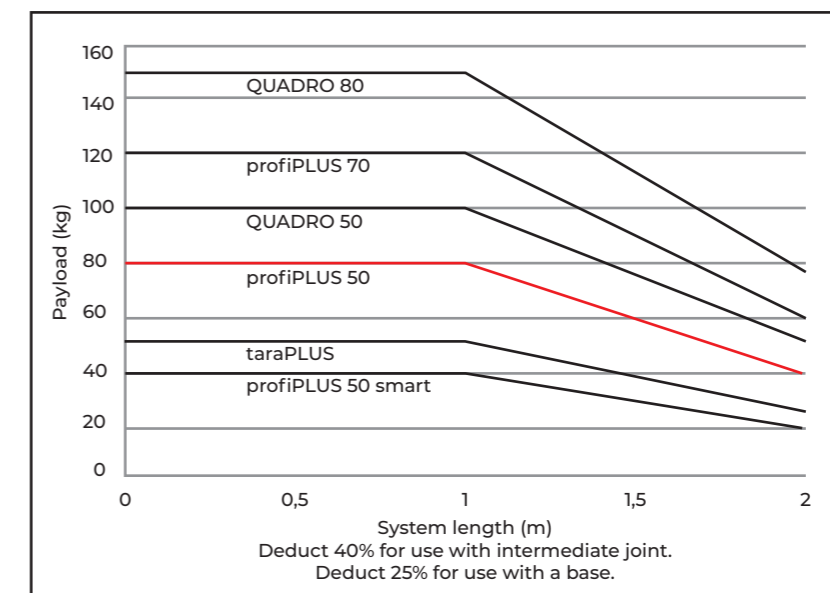

You can find detailed information on this product in our separate brochure »profiPANEL – multiPANEL – profiPLUS 50/70« and available to download on our website, www.rolec.de



Ingress protection IP 54

profiPLUS 70

The designer suspension system

The design harmonises perfectly with that of machinery. Time-saving assembly, a range of system components and the possibility to adapt to the 50-series system in order to use all 50-series connections give the system an unrivalled advantage.

The key product features:

- System parts material: Die-cast aluminium, powder coating, RAL 7035
- Suspension profile material: Aluminium profile, in anodised silver
- '70/50 adaptation', e.g. in order to use the adapter with the panel manufacturers listed together with profiPLUS 50
- Many couplings with pre-fitted suspension profile as standard
- Can be used with all ROLEC control enclosures; the perfect complement to 'multiPANEL' and 'profiPANEL'
- Possible to route connectors such as HDMI, DVI, network adapters, etc.
- Comprehensive potential equalisation
- Ingress protection IP 54
- Gasket: Chloroprene (CR)



Standard: Integrated cable protection in all joint parts.



Standard: Integrated set screw system for adjusting the pivoting range.



70/50 adaptor for the transition to profiPLUS 50 couplings.



Signal light adapter for joint and elbow.

System components	Art. no.	Hanging	Upright	Pivoting	Horizontally adjusting	Adjustable	Support profile length* mm	Weight / g
Coupling **	143.240.250		•	•			250	2210
	143.240.500		•	•			500	3590
	143.240.750		•	•			750	4970
	143.241.000			•	•		1000	6350
	143.250.250	•		•			250	2210
	143.250.500	•		•			500	3590
	143.250.750	•		•			750	4970
	143.251.000	•		•			1000	6350
Coupling N **	143.260.250		•	•		•	250	3590
	143.260.500		•	•		•	500	4970
	143.260.750		•	•		•	750	6350
	143.261.000			•	•		1000	7730
	143.270.250	•		•		•	250	3590
	143.270.500	•		•		•	500	4970
	143.270.750	•		•		•	750	6350
	143.271.000	•		•		•	1000	7730
Desk coupling N **	143.280.250		•	•		•	250	4700
	143.280.500		•	•		•	500	6080
	143.280.750		•	•		•	750	7460
	143.281.000			•	•		1000	8840
	143.290.250	•		•		•	250	4700
	143.290.500	•		•		•	500	6080
	143.290.750	•		•		•	750	7460
	143.291.000	•		•		•	1000	8840
Elbow coupling	143.034.000		•	•				1740
	143.035.000	•		•				1740
Elbow coupling N	143.036.000		•	•		•		3120
	143.037.000	•		•		•		3120
Elbow desk coupling N	143.038.000		•	•		•		4260
	143.039.000	•		•		•		4260
Wall joint	143.010.000		•	•	•			6800
Socket joint	143.005.000		•	•	•			5380
Wall joint, upright	143.010.001			•				6200
Socket joint, upright	143.005.001			•				4300

*For explanation see next page

Approvals:



System components	Art. no.	Hanging	Upright	Pivoting	Horizontally adjusting	Adjustable	Support profile length* mm	Weight / g
Intermediate joint	143.015.000	•	•					5320
Elbow	143.020.000							870
Base ***	143.030.000	•	•					1620
Support profile 250 mm	143.000.250						250	1380
Support profile 500 mm	143.000.500						500	2760
Support profile 750 mm	143.000.750						750	4140
Support profile 1000 mm	143.001.000						1000	5520
Support profile 1500 mm	143.001.500						1500	8280
70/50 Adaptor	143.000.001	•	•					370
Signal light adaptor, joint	143.020.501							180
Signal light adaptor, elbow	143.020.502							200
Elbow coupling 70/48	143.020.002	•	•	•				1680

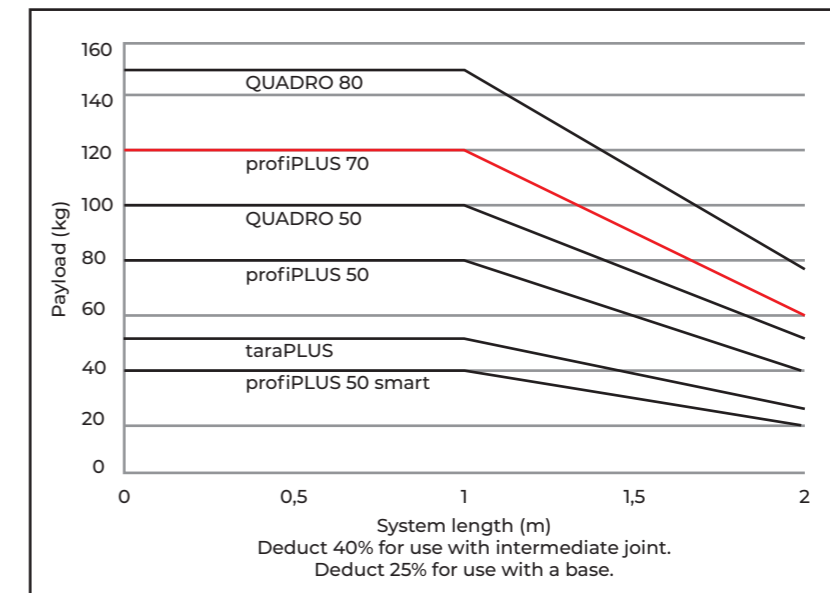

- Functional features
- * Special lengths available on request
- ** Delivery with support profile fitted
- *** Horizontal and vertical installation possible

Ingress protection IP 54

taraPLUS

The multi-variable suspension system

The special design combines round and square profiles, thereby achieving high static equilibrium. Large openings in the system parts allow cables to be easily fed through.

The key product features:

- Profile cross-sections: round Ø 48 and 70 mm, rectangular 40x60 mm
- System parts material: Die-cast aluminium, powder coating, RAL 7040
- Suspension profile material: drawn steel, powder coating, RAL 7035
- Simple and quick adjustment with set screws
- Can be used with all ROLEC control enclosures
- Possible to route connectors such as HDMI, patch cable, USB, etc. (not for DVI connectors)
- Ingress protection IP 54
- Gasket: Chloroprene (CR)

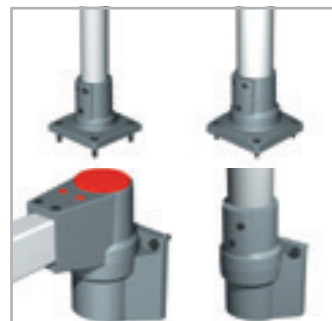

Various connections available.

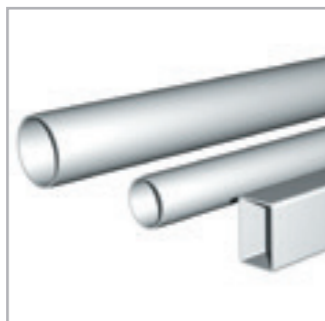

Support profiles: a combination of round and/or rectangular tubes.

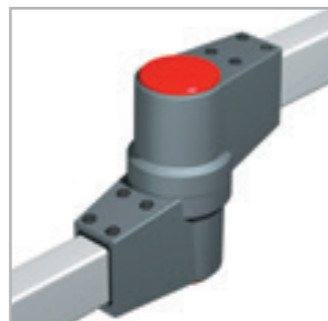

Intermediate joint, articulated.

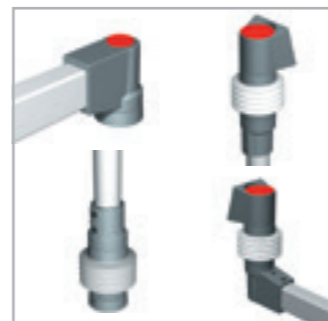

Various couplings available.

System components	Art. no. RAL 7040	Art. no. RAL 7031	Hanging	Upright	Pivoting	Adjusting	Weight / g
Coupling, hanging	149.025.500	149.025.510	•		•		480
Coupling, upright	149.025.501	149.025.511		•	•		480
Elbow coupling	149.035.000	149.035.010			•		1100
Elbow 48	149.020.000	149.020.010	•				800
Elbow 70	149.020.001	149.020.011	•				1800
Base 48	149.030.000	149.030.010		•			700
Base 70	149.030.001	149.030.011		•			1150
Socket joint	149.005.000	149.005.010					2450
Socket joint, vertical	149.005.001	149.005.011		•			1700
Wall joint	149.010.000	149.010.010					2750
Wall joint, vertical	149.010.001	149.010.011	•	•			2000
Tube rotation joint	149.040.000	149.040.010	•		•		2300
Intermediate joint	149.015.000	149.015.010			•		3000
Coupling A	149.025.001	149.025.011	•		•	•	1350
Elbow coupling A	149.035.001	149.035.011	•		•	•	1800
Console coupling	149.025.002	149.025.012					1050
Console coupling A, upright	149.025.003	149.025.013		•	•	•	2150
Console coupling A, hanging	149.025.004	149.025.014	•		•	•	2150
Elbow console coupling	149.035.002	149.035.012			•		1500
Elbow console coupling A, upright	149.035.003	149.035.013		•	•	•	2600
Elbow console coupling A, hanging	149.035.005	149.035.015	•		•	•	2600
Wall inclination coupling	149.045.000	149.045.010			•	•	3500

Approvals:



System components	Art. no. RAL 7040	Art. no. RAL 7031	Hanging	Upright	Pivoting	Adjustable	Weight / g
taraPLUS/QUADRO 50 elbow	149.021.000	149.021.010	•	•			1480
TUBES							
Round tube Ø48 250 mm	144.300.250	144.330.250					900
Round tube Ø48 500 mm	144.300.500	144.330.500					1800
Round tube Ø48 750 mm	144.300.750	144.330.750					2700
Round tube Ø48 1000 mm	144.301.000	144.331.000					3600
Round tube Ø70 250 mm	144.320.250	144.340.250					1725
Round tube Ø70 500 mm	144.320.500	144.340.500					3450
Round tube Ø70 1000 mm	144.321.000	144.341.000					6900
Round tube Ø70 1500 mm	144.321.500	144.341.500					10350
Round tube Ø70 2000 mm	144.322.000	144.342.000					13800
Rectangular tube 60/40 500 mm	144.310.500	144.350.500					1800
Rectangular tube 60/40 750 mm	144.310.750	144.350.750					2700
Rectangular tube 60/40 1000 mm	144.311.000	144.351.000					3600
Rectangular tube 60/40 1500 mm	144.311.500	144.351.500					5400

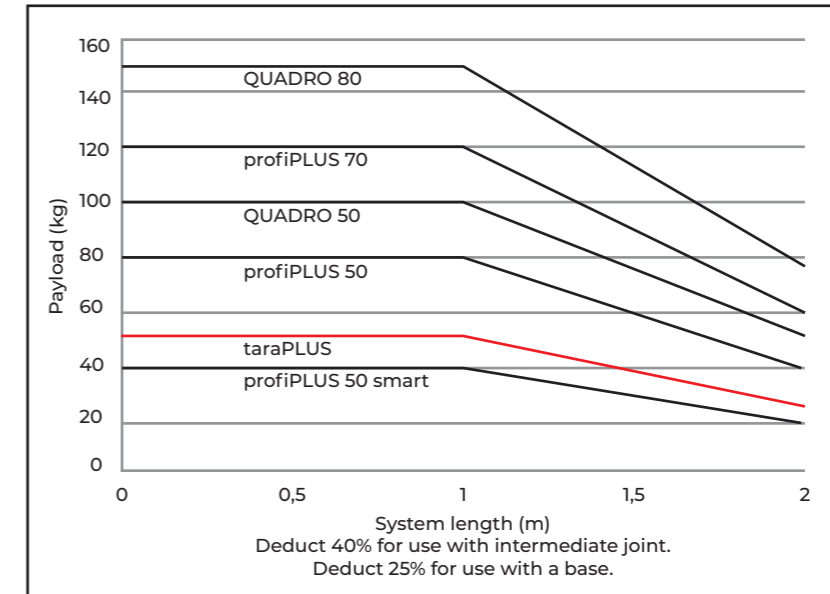

Ingress protection IP 54

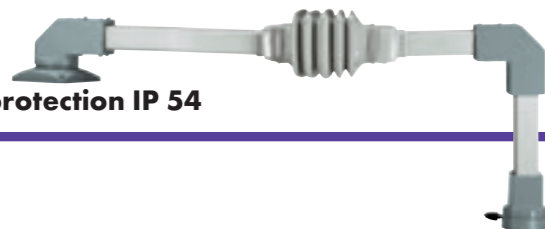

QUADRO 50/80

Suspension system for heavy loads

The system consists of spheroidal graphite parts that provide higher-than-average bearing strength. The overall static equilibrium of the system is also very high due to its combination with steel profiles.

The most important product features:

- Profile cross-sections: Square 50 and 80 mm
- System parts material: die-cast aluminium / spheroidal graphite iron, powder coating, RAL 7040
- Suspension profile material: drawn steel, powder coating, RAL 7035
- transition from square 50 mm (QUADRO 50) to round Ø48 mm (taraPLUS) possible through special elbow
- Can be used with all ROLEC control enclosures
- Possible to route connectors such as HDMI, DVI, network adapters, etc.
- Ingress protection IP 54
- Gasket: Chloroprene (CR)



Various connections available.

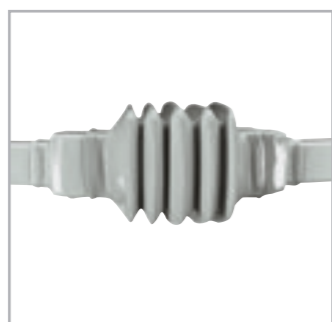

Intermediate joint with bellows.

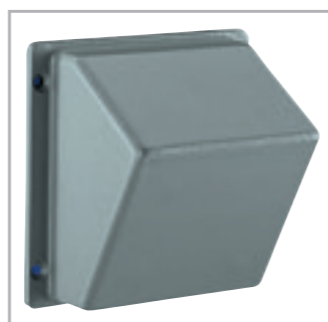

Inclination adaptor 30 and 60 degrees.



Signal light adaptor for QUADRO 50 and 80 elbows.

System components	Art. no. QUADRO 50	Weight / g	Art. no. QUADRO 80	Weight / g	Hanging	Upright	Pivoting	Adjustable
Coupling	147.025.500	1250	147.025.700	3100	•	•	•	
Elbow coupling	147.035.500	2000	147.035.700	6550	•	•	•	
Elbow	147.020.500	1350	147.020.700	2400	•	•		
taraPLUS/QUADRO 50 elbow	149.021.000	1480			•	•		
Signal light adaptor	147.020.501	25	147.020.701	80		•		
Intermediate joint	147.015.000	4250	147.015.200	10000				•
Wall joint	147.010.000	4350	147.010.200	9450				•
Socket joint	147.005.500	5400	147.005.700	15700			•	•
Tube rotation joint	147.040.000	6650			•	•	•	
Base	147.030.000	3250	147.030.200	7000		•		
Coupling A	147.025.002	3000	147.025.202	2900	•	•		•
Inclination adaptor 30/60 degrees	140.045.000	1100	140.045.000	1100				
Square tube 500 mm	144.020.500	3375	144.040.500	3375				
Square tube 1000 mm	144.021.000	6750	144.041.000	6750				
Square tube 1500 mm	144.021.500	10125	144.041.500	10125				
Square tube 2000 mm	144.022.000	13500	144.042.000	13500				

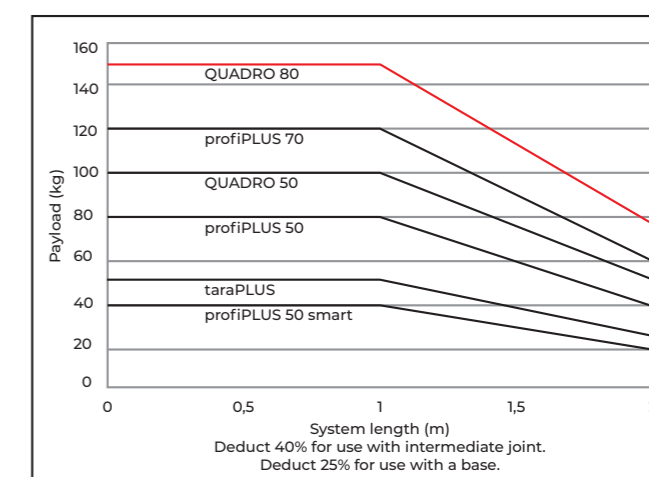
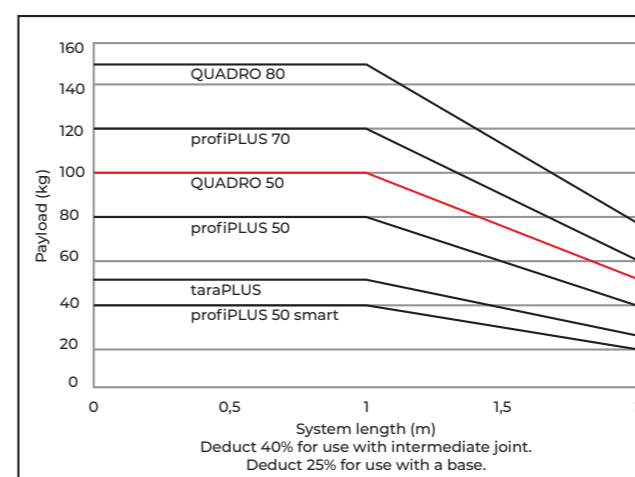

Approvals:



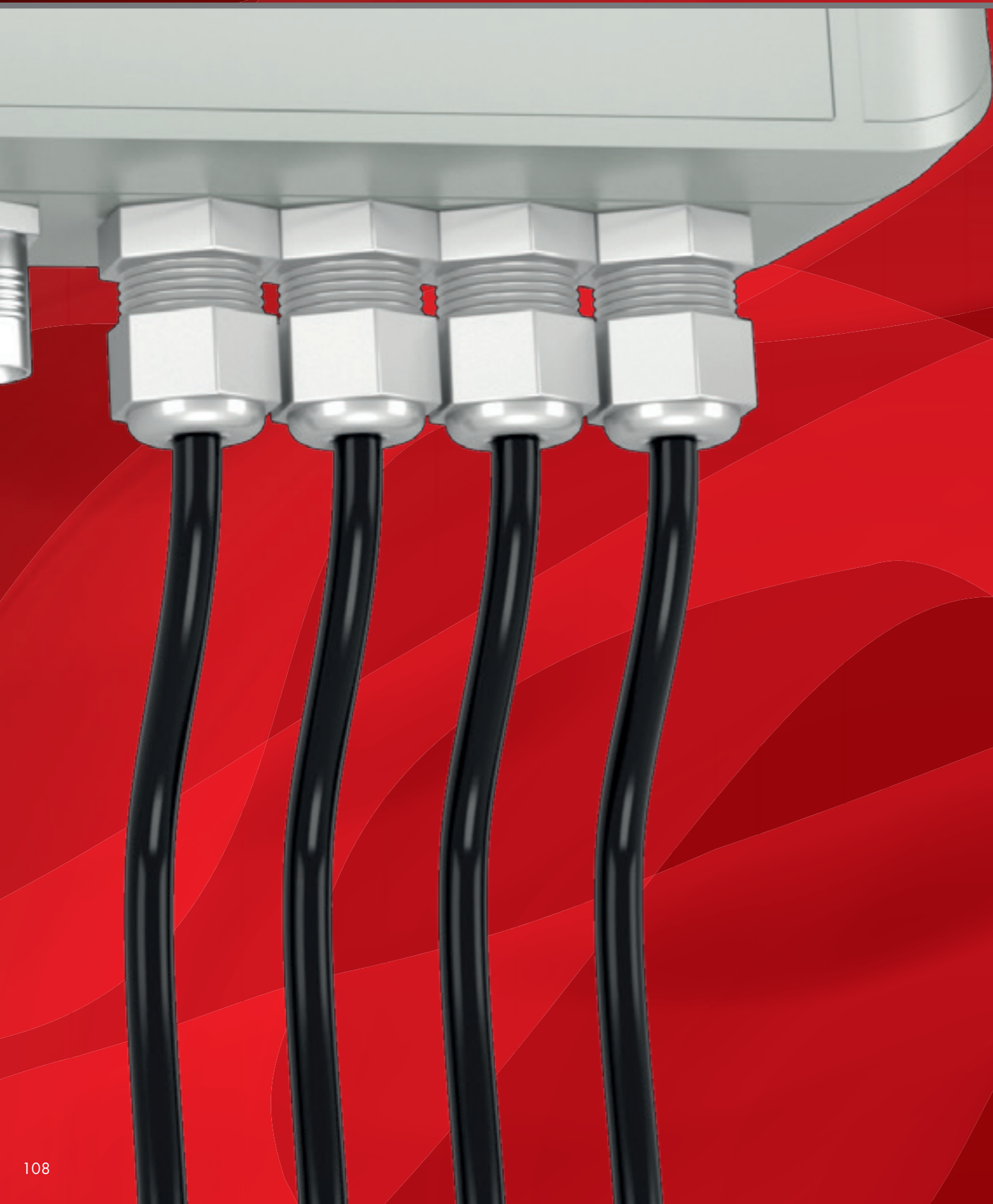

Cable glands & accessories

Suitable solutions for every application



Brass tight cable gland

Material: Brass, nickel-plated
Gasket: Neoprene
Ingress protection: IP 68/5 bar
Good strain relief. With O-ring on the connection thread.

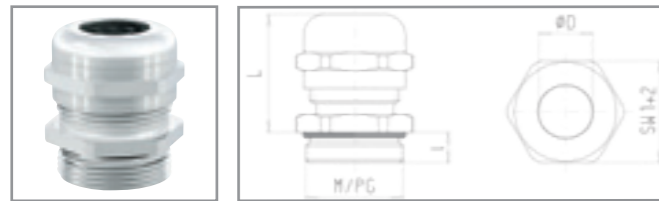

Art. no.	M	Ø	I	L	SW1	SW2	PU
570.002.M12	M12	3-6.5	6	22	14	14	50
570.002.M16	M16	5-10	7	28.5	20	20	50
570.002.M20	M20	6-12	8	26.5	22	22	50
570.002.M25	M25	11-17	8	32.5	27	27	25
570.002.M32	M32	15-21	8	36	34	34	10
570.002.M40	M40	19-28	9	43.5	43	43	10
570.002.M50	M50	27-38	9	52	58	58	5
570.002.M63	M63	34-44	14	53	68	64	5

Brass cable gland EMC version

Material: Brass, nickel-plated
Gasket: Neoprene
Ingress protection: IP 68/5 bar
O-ring from Perbunan on the connection thread.

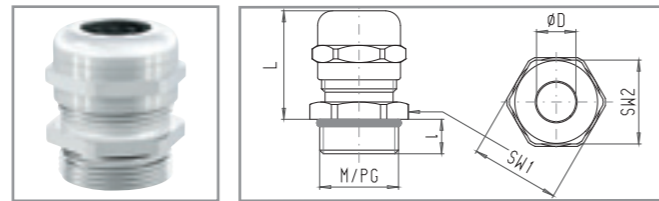

Art. no.	M	Ø	I	L	SW1	SW2	PU
570.801.M12	M12	3-6.5	6	22	14	14	50
570.801.M16	M16	4-8	7	23	18	17	50
570.801.M20	M20	6-12	8	27.5	22	22	50
570.801.M25	M25	11-17	8	30.7	27	27	25
570.801.M32	M32	15-21	8	38	34	34	10
570.801.M40	M40	19-28	9	43	43	43	5
570.801.M50	M50	27-38	9	54.5	58	58	5
570.801.M63	M63	34-44	14	53	68	64	5

PE O-ring gasket

Material: Polyethylene



Art. no.	M	t	Ø1	Ø2	PU
570.012.M12	M12	2	12	16	1
570.012.M16	M16	2	16	20	1
570.012.M20	M20	2	20	24	1
570.012.M25	M25	2	25	29	1
570.012.M32	M32	2	32	36	1
570.012.M40	M40	2	40	45	1
570.012.M50	M50	2	50	56	1
570.012.M63	M63	2	63	70	1

Plastic blanking plug

Material: Polyamide
Surface: RAL 7035; further colours on inquiry
Ingress protection: IP 54

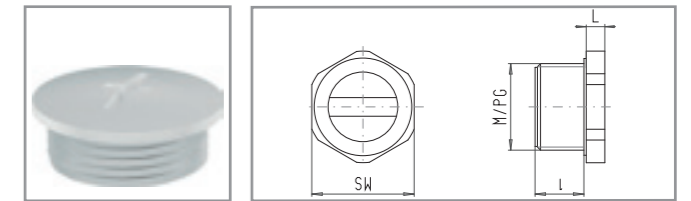

Art. no.	M	Ø	I	L	PU
570.009.M12	M12	15	6	2	100
570.009.M16	M16	20	6	3	100
570.009.M20	M20	24	6	3.5	100
570.009.M25	M25	30	8	3.5	100
570.009.M32	M32	37	8	4	100
570.009.M40	M40	46	8	5	50
570.009.M50	M50	56	10	5	50
570.009.M63	M63	69	12	5	25

Brass lock nut

Material: Brass, nickel-plated

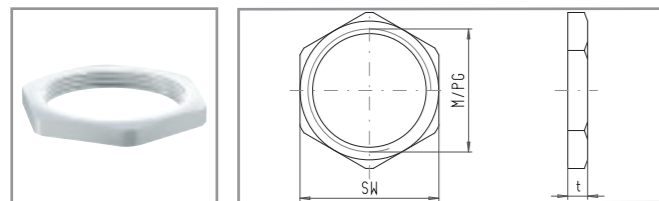

Art. no.	M	t	SW	PU
570.005.M10	M10	3	14	100
570.005.M12	M12	2.8	15	100
570.005.M16	M16	2.8	19	100
570.005.M20	M20	3	24	100
570.005.M25	M25	3.5	30	100
570.005.M32	M32	4	36	100
570.005.M40	M40	5	46	50
570.005.M50	M50	5	57	25
570.005.M63	M63	6	70	25

Brass blanking plug

Material: Brass, nickel-plated
Gasket: O-ring from Perbunan
Ingress protection: IP 68

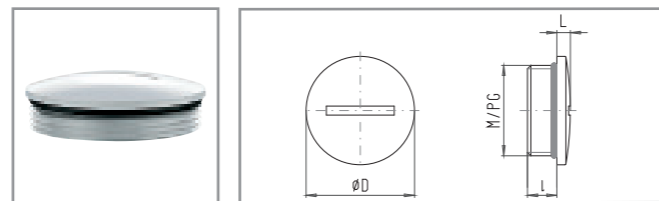

Art. no.	M	Ø	I	L	PU
570.004.M12	M12	14	5	2.5	100
570.004.M16	M16	18	5	3	100
570.004.M20	M20	22	6	2.5	100
570.004.M25	M25	28	7	4	100
570.004.M32	M32	35	8	4	50
570.004.M40	M40	44	8	5	50
570.004.M50	M50	54	9	6	25
570.004.M63	M63	67	10	6	10

PA cable gland

Material: Polyamide
Gasket: Neoprene
Surface: RAL 7035; further colours on inquiry
Ingress protection: IP 68/5 bar
VDE and UL-checked.

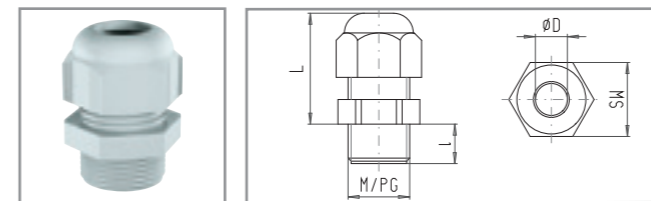

Art. no.	M	Ø	I	L	SW	PU
570.014.M12	M12	3-6.5	8	23	15	100
570.014.M16	M16	5-10	10	30	22	50
570.014.M20	M20	6-12	10	30	24	50
570.014.M21	M20	10-14	10	31	27	50
570.014.M25	M25	13-18	10	37	33	25
570.014.M32	M32	18-25	15	41	42	20
570.014.M40	M40	22-31	18	52	53	10
570.014.M50	M50	30-36	18	53	60	10
570.014.M63	M63	34-44	18	53	65	10

Plastic lock nut

Material: Polyamide
Surface: RAL 7035
Standard: DIN EN 60423

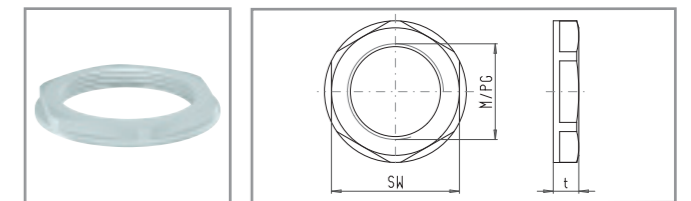

Art. no.	M	t	SW	PU
570.010.M12	M12	5	18	100
570.010.M16	M16	5	22	100
570.010.M20	M20	6	26	100
570.010.M25	M25	6	32	100
570.010.M32	M32	7	41	100
570.010.M40	M40	7	50	50
570.010.M50	M50	8	60	50
570.010.M63	M63	8	75	50

Ø = Clamping area in mm

V2A – pressure equalisation element
 Material: Stainless steel V2A
 Ingress protection: IP 66/68/69K

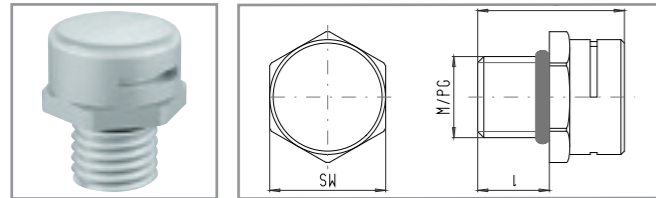

Art. no.	M	I	L	SW	PU
570.001.112	M12	10	21	17	1

PA – pressure equalisation element
 Material: Polyamide
 Surface: RAL 7035
 Ingress protection: IP 66/68/69K

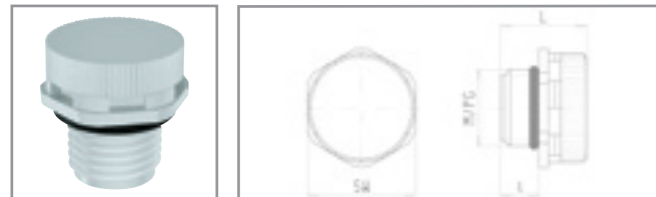

Art. no.	M	I	L	SW	PU
570.004.112	M12	6	14	17	1

Ø = Clamping area in mm

In addition to the standard components shown here, we can also supply alternative products from other manufacturers on request. Talk to our sales team. All information is subject to change without prior notice. Claims for typographical or other errors are will not be accepted.

Accessories

Suitable solutions for every application

Visit our website to find the matching standard accessories for each individual item number. For further accessories, please get in touch with our sales experts.

Accessories for the ROLEC enclosure range:

- Hinges, special seals, supporting rails, terminals, cable glands, pressure equalisation elements, external mounting brackets for wall-mounted enclosures
- Stand up shackles for table-mounted enclosures
- A range of accumulator holders, carry straps, wall brackets, handles, holding clips and suspension arm adaptors



Example customers

An small selection from our customer base



For your notes

Space for drawing or writing

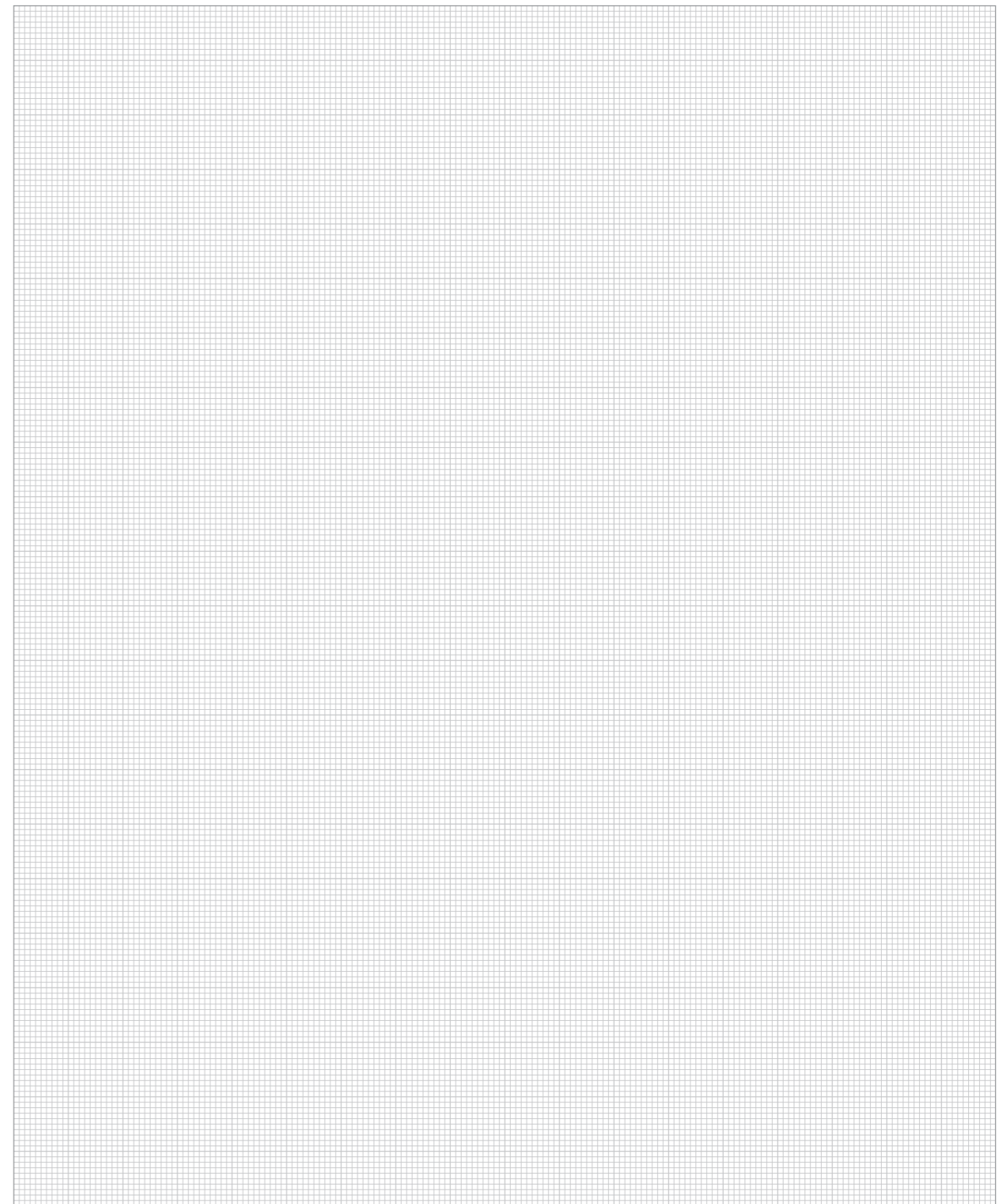

With our good name, that is what we stand for.

Thanks to our numerous customers, large and small, we have been around for over 30 years.

With innovativeness and great expertise, we have been developing and producing enclosures, suspension systems and command enclosures for customers in the fields of industry, measurement technology, electrical engineering, research & development, machinery and plant engineering.

When a customer has a question, then we listen attentively. When a customer has a special need, we try to meet it. This is how we constantly improve our products, our services and our long-term business relationships.

ROLEC provides its customers with first-class products and services. We provide support for customer requirements to the greatest extent possible with our on-site presence. We create true added value for our customers' applications.

Information in our technical data is non-binding. All information is provided to the best of our knowledge, although the actual applications lie outside our sphere of influence. Therefore, the information we provide does not release the buyer from the responsibility of checking the products for their suitability for the intended processes and purposes. We reserve the right to make technical changes and to further develop our products. Any such changes, as well as errors and misprints shall not give rise to claims for compensation. Our complete product range has been RoHS-compliant since 1 March 2005. In the future, we shall continue to supply to customers who demand specific processes, because their products do not fall under the scope of directive 2011/65/EU.



Our *passion* is enclosures.



Think tank, technology leader, problem solver and a partner that you can trust. That is what makes ROLEC what it is and what it will always be.



Matthias Rose, ROLEC managing director

ROLEC
Gehäuse-Systeme GmbH
Kreuzbreite 2
D-31737 Rinteln

Fon +49 (0) 5751 4003-0
Fax +49 (0) 5751 4003-50
info@rolec.de
www.rolec.de

